



CAIXAS

LINHA LEVE

LINHA LEVE

LINHA LEVE

LINHA LEVE

CENTRAL DE VENDAS

(11) 95456-6290

(11) 94538-8656

(11) 95796-0176

(11) 95804-9330

(11) 97895-9270

(11) 95968-7415

(11) 95824-7581

vendas@supersoldas.com.br (Alessandra)

andreia@supersoldas.com.br

carla@supersoldas.com.br

evelyn@supersoldas.com.br

fabiana@supersoldas.com.br

fernanda@supersoldas.com.br

ketlyn@supersoldas.com.br

10

Doblò Superior
Mangureira C/Ar



420mm x 42mm

15

Doblò Inferior C/Ar



420mm x 42mm

20

Ducato Inferior



427mm x 48mm

30

Ducato Superior



427mm x 48mm

40

Fiorino / Spazio Inferior



324mm x 46mm

50

Fiorino / Spazio Superior



324mm x 46mm

60

Marea Inferior



580mm x 45mm

70

Marea Superior



580mm x 45mm

75

Marea Superior
Largo Fechado



585mm x 59mm

76

Marea Inferior Largo



585mm x 59mm

77

Marea Superior
Largo Aberto



585mm x 59mm

80

Palio 1.5 Inferior



360mm x 46mm

90

Palio 1.5 Superior Bocal



360mm x 46mm

91

Palio 1.5 Superior Bocal
Cebolão Fechado



360mm x 46mm

100

Palio Fire Inferior
Canelado



392mm x 45mm

105

Palio Fire Canelado
Superior C/ Divisor Reto



390mm x 42mm

110

Palio Fire Canelado
Superior C/ Divisor Torto



390mm x 41mm

120

Palio Fire Inferior
Liso



378mm x 42mm

130 / Palio Fire Superior Liso



378mm x 42mm

135 / Palio Fire Superior Similar Visconde



390mm x 41mm

136 / Palio Fire Inferior Similar Visconde

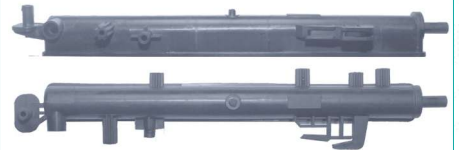

390mm x 41mm

137 / Palio Fire Superior Similar Denso



377mm x 38mm

138 / Palio Fire Inferior Similar Denso

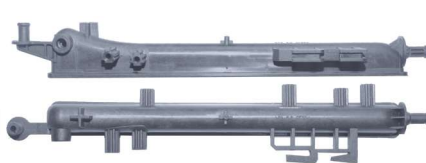

377mm x 38mm

140 / Palio Reservatório



360mm x 42mm

141 / Palio 1.0 Inferior



360mm x 42mm

145 / Toro Inferior 2018 1.8 16V



405mm x 31mm

146 / Toro Superior Lado Sangrador 2018 1.8 16V



405mm x 28mm

147 / Renegade Inferior Diesel 2015>2019



420mm x 39mm

148 / Renegade Superior Diesel 2015>2019

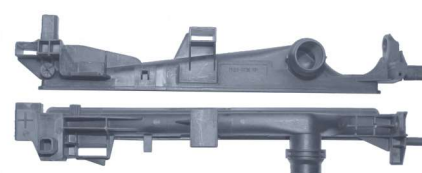

420mm x 39mm

150 / Tempra Inferior



360mm x 46mm

151 / Toro Diesel Bocal Longo



421mm x 41mm

152 / Toro Diesel Bocal Curto



421mm x 41mm

160 / Tempra Superior



360mm x 46mm

170 / Tipo Inferior



386mm x 49mm

180 / Tipo Superior



386mm x 49mm

189 / Uno Inferior Similar Denso



322mm x 37mm

190 / Uno Inferior



322mm x 47mm

191 / Uno Superior Fino



399mm x 24mm

192 / Uno Inferior Fino



399mm x 24mm

193 / Novo Uno/Palio/Siena/Mobi
Sim. Denso S/Ret. 4Cilindros



379mm x 37mm

194 / Novo Uno/Palio/Siena/Mobi
Sim. Denso C/Ret. 4Cilindros



379mm x 37mm

195 / Uno LX Argentino C/ Ar



322mm x 47mm

196 / Uno Vivace Superior
Similar Visconde



390mm x 42mm

197 / Uno Vivace Inferior
Similar Visconde



390mm x 42mm

200 / Uno Reservatório



322mm x 47mm

202 / Uno Reservatório
Similar Denso



322mm x 37mm

203 / Punto 1.4 Superior
Similar Denso

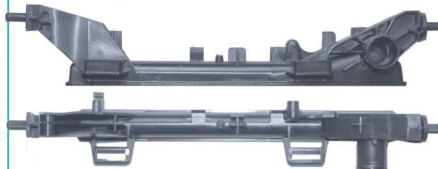

378mm x 37mm

204 / Punto 1.4 Inferior
Similar Denso



378mm x 37mm

205 / Stilo Superior 2 Bocais



423mm x 54mm

206 / Stilo Inferior C/ Respiro



423mm x 54mm

207 / Stilo Inferior S/ Respiro



423mm x 54mm

7208 / Linea 2 Bocais



420mm x 42mm

7209 / Linea Inferior



420mm x 42mm

7350 / Mobi / Uno 1.0 6V 2017
2019 Lado Carona



406mm x 33mm

7460 / Mobi / Uno 1.0 6V 2017
2019 Lado Motorista



406mm x 33mm

7890 / Toro 1.3 Bocal Curto



490mm x 42mm

8015 / Argo / Cronos Superior
8V/16V 1.3/1.8



404mm x 30mm

8016 / Argo / Cronos Inferior
8V/16V 1.3/1.8



404mm x 30mm

8023 / Fastback / Pulse 1.0/1.3
Turbo 21/22 Superior



445mm x 30mm

8200 / Toro/Compass/Renegade
1.3 Flex C/ 2 Bocais



445mm x 30mm

8201 / Toro/Compass/Renegade
1.3 Flex S/ Bocal



442mm x 30mm

8220 / Fastback / Pulse 1.0/1.3
Turbo 21/22 Inferior



445mm x 30mm

8290 / Fastback / Pulse 1.0/1.3
Turbo 21/22



490mm x 42mm

8310 / Pulse / Fastback 1.0/1.3
Turbo 21/22 Bocal Curto



490mm x 42mm

8361 / Nova Strada 1.3 Flex



407mm x 31mm

8370 / Nova Strada 1.4 20/21
Lado Mangueira



407mm x 33mm

8380 / Strada 1.4 20/21
Com Ar



407mm x 33mm

8421 / Toro 2.4 Jeep Compass
2.0 / 2.4 Superior



420mm x 41mm

8422 / Toro 2.4 Jeep Compass
2.0 / 2.4 Inferior



420mm x 41mm

7623 / 116 / 120 / 128-I / Z4
X1 09> Superior



475mm x 48mm

209 / Corcel / Pampa / Belina



325mm x 47mm

210 / Escort 86



326mm x 48mm

220 / Escort / Verona Inferior Cebolão



323mm x 35mm

230 / Escort / Verona Superior



323mm x 35mm

240 / Escort Zetec Inferior



372mm x 62mm

241 / Escort Zetec Superior

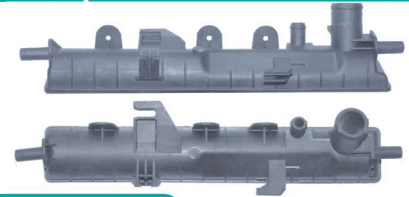

372mm x 62mm

242 / Fiesta / Courier - Zetec Lado Mangueira



360mm x 42mm

250 / Fiesta / Courier Inferior C/ Bico



360mm x 42mm

260 / Fiesta Curto S/ Ar



305mm x 42mm

261 / Fiesta Inferior Curto S/ Ar

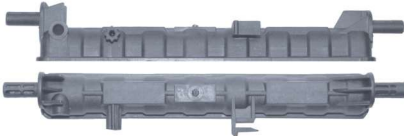

305mm x 42mm

270 / Fiesta Largo C/ Ar



365mm x 48mm

280 / Fiesta Longo C/ Ar



360mm x 42mm

281 / Fiesta Longo Inferior C/ Ar C/ Mangueira na Ponta



360mm x 42mm

282 / Fiesta Longo Inferior C/ Ar S/ Mangueira

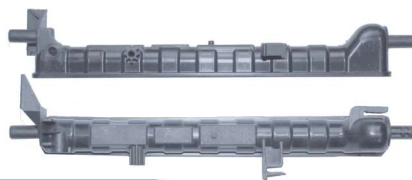

360mm x 42mm

290 / Fiesta Novo / Courier Ecosport Inferior



360mm x 42mm

300 / Fiesta Novo / Courier Ecosport Superior



360mm x 43mm

302 / Novo Ecosport / Ka New Fiesta C/ Retorno



562mm x 42mm

303 / Novo Ecosport / Ka New Fiesta S/ Retorno



562mm x 42mm

304 / New Fiesta / Ecosport / Ka Inferior

562mm x 42mm

305 / F-250 / F-350 / F-4000 Superior G

780mm x 76mm

306 / F-250 / F-350 / F-4000 Inferior G

780mm x 76mm

307 / F-250 / F-350 / F-4000 Superior P

772mm x 76mm

308 / F-250 / F-350 / F-4000 Inferior P

772mm x 76mm

310 / Ka Brazado Inferior

365mm x 45mm

311 / Ecosport Mangueira no Meio S / Retorno - 30MM

562mm x 34mm

312 / Novo Ecosport / Ka New Fiesta S/ Retorno

562mm x 41mm

313 / Ecosport Mangueira no Meio C / Retorno - 30MM

562mm x 34mm

314 / Ecosport Mangueira no Meio C / Retorno

562mm x 34mm

315 / Ranger Superior 2013> / Troller

658mm x 45mm

316 / Ranger Inferior 2013> C / Sangrador / Troller

658mm x 45mm

317 / Ranger Inferior 2013> S / Sangrador

658mm x 45mm

318 / Ecosport 2.0 Superior AT 2018>

725mm x 35mm

319 / Ecosport 18/19 C/ Mangueira no Meio

725mm x 35mm

320 / Ka Largo Bocal C/Ar

365mm x 48mm

322 / Ecosport Mangueira no Meio S / Retorno - 24MM

562mm x 34mm

323 / Ecosport Mangueira no Meio C / Retorno - 24MM

562mm x 34mm

330 / Ka Largo Bocal S/Ar

365mm x 48mm

340 / Ka Similar Valeo

360mm x 42mm

341 / Ka Similar Valeo Inferior C/ Retorno

360mm x 42mm

342 / Ka Similar Valeo Inferior S/ Retorno

360mm x 42mm

343 / Focus C/ 02 Retornos

365mm x 45mm

344 / Focus Lado Sangrador

365mm x 45mm

345 / Ranger C/ Respiro

438mm x 45mm

346 / Ranger S/ Respiro

438mm x 45mm

365 / Focus C/ 01 Retorno

365mm x 45mm

366 / Focus S/ Retorno

365mm x 45mm

367 / New Focus Lado Sangrador

370mm x 31mm

368 / New Focus Lado Entrada

370mm x 31mm

7707 / Focus 2010 S/ Bico

389mm x 37mm

7708 / Focus 2010 C/ Bico

389mm x 37mm

7887 / Focus 2010 S/ Bico Lisa

389mm x 37mm

7888 / Focus 2010 C/ Bico Lisa

389mm x 37mm

7938 / Ecosport / Fiesta 03/10 AT Lado Bocal

361mm x 43mm

348 / Agile C/ Retorno

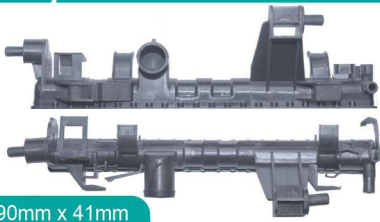

390mm x 41mm

349 / Agile Mangueira na Ponta



390mm x 41mm

350 / Astra Bico



390mm x 40mm

351 / Astra 95 C/ 2 Cebolões



367mm x 47mm

353 / Astra Novo Mangueira na Ponta



389mm x 32mm

354 / Astra Novo Lado Retorno



389mm x 32mm

355 / Astra Sangrador Similar Visconde

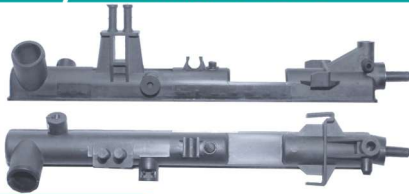

390mm x 40mm

356 / Astra Bico Similar Visconde



390mm x 40mm

357 / Astra Novo Mangueira na Ponta Similar Visconde



389mm x 32mm

358 / Astra Novo Lado Retorno Similar Visconde



389mm x 32mm

360 / Astra Sangrador

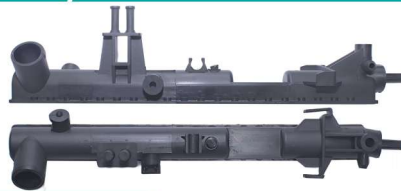

390mm x 40mm

361 / Blazer 4.3 Elemento Óleo Aberto



417mm x 57mm

362 / Blazer 4.3 Elemento Óleo Fechado



417mm x 57mm

363 / Blazer Tampa Elemento Óleo Fechado



417mm x 57mm

364 / Blazer Tampa Elemento Óleo Aberto



417mm x 57mm

370 / Celta Inferior C/ Ar



285mm x 42mm

380 / Celta Inferior S/ Ar



285mm x 42mm

390 / Celta / Prisma C/ Retorno



323mm x 42mm

395 / Celta / Prisma S/ Retorno Similar Visconde



325mm x 48mm

396 / Celta / Prisma C/ Retorno Similar Visconde



325mm x 48mm

400 / Celta / Prisma S/ Retorno



324mm x 43mm

401 / Celta / Prisma 2 Mangueiras



323mm x 43mm

402 / Agile C/Retorno Similar Visconde



390mm x 42mm

403 / Agile Mangueira na Ponta Similar Visconde



392mm x 42mm

404 / Zafira Nova 09> Mang. Meio C/ Elemento Similar Visconde



395mm x 55mm

405 / Zafira Nova 09> Mang. Meio S/ Elemento Similar Visconde



395mm x 55mm

410 / Celta Reservatório



285mm x 42mm

420 / Corsa Canelado



300mm x 40mm

425 / Corsa Canelado Inferior



300mm x 40mm

430 / Corsa Inferior C/ Ar



280mm x 46mm

440 / Corsa Liso Inferior



285mm x 42mm

450 / Corsa Liso Superior Cebolão Aberto



285mm x 42mm

460 / Corsa Liso Superior Cebolão Fechado



285mm x 42mm

470 / Corsa / Montana (Bocal)



390mm x 40mm

471 / Corsa / Montana Bocal Similar Visconde



390mm x 40mm

472 / Corsa / Montana Bocal Importada



379mm x 40mm

480 / Corsa / Montana Sangrador



390mm x 40mm

481 / Corsa / Montana Sangrador Similar Visconde

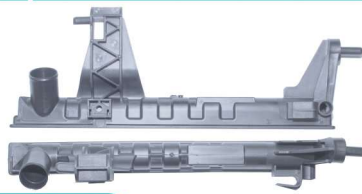

390mm x 40mm

482 / Corsa / Montana Sangrador Importada

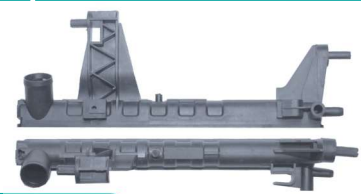

379mm x 40mm

490 / Corsa Superior C/ Ar Cebolão Aberto



280mm x 48mm

500 / Corsa Superior C/ Ar Cebolão Fechado



280mm x 48mm

501 / Corsa Classic Superior S/ Retorno 2010>

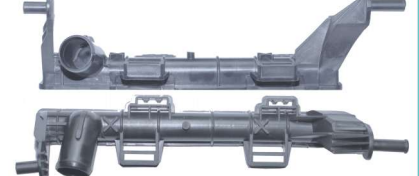

304mm x 37mm

502 / Corsa Classic Inferior C/ Retorno 2010>



304mm x 37mm

503 / Onix/Sonic/Novo Prisma C/ Retorno



378mm x 32mm

504 / Onix/Sonic/Novo Prisma S/ Retorno



378mm x 32mm

505 / Cruze Inferior C/ Elemento

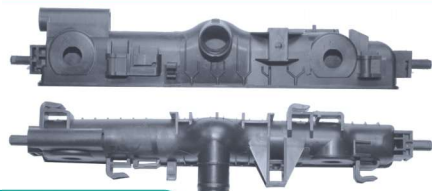

408mm x 48mm

506 / Cruze Inferior S/ Elemento



408mm x 48mm

507 / Cruze Superior Lado Sangrador



408mm x 48mm

510 / Meriva Bico

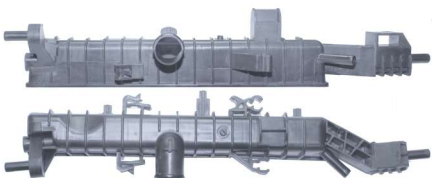

375mm x 55mm

520 / Meriva Sangrador



375mm x 55mm

530 / Monza Bico



417mm x 48mm

535 / Monza Brasado Inferior



408mm x 47mm

540 / Monza Cebolão

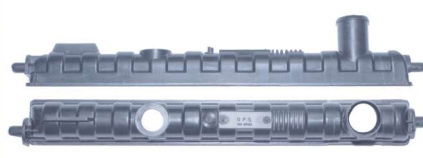

417mm x 48mm

550 / Monza / Kadett Brasado Cebolão Aberto



410mm x 48mm

560 / Monza / Kadett Brasado Cebolão Fechado



410mm x 48mm

570 / Monza / Kadett Inferior Fino



416mm x 37mm

580 / Monza / Kadett Superior Fino Aberto



416mm x 37mm

582 / Monza / Kadett Superior Fino Fechado



416mm x 37mm

583 / Omega 3.0 Inferior C/ Elemento de Óleo



484mm x 60mm

584 / Omega 3.0 Inferior S/ Elemento de Óleo



484mm x 60mm

585 / Omega 3.0 Superior Lado Cebolão



484mm x 60mm

587 / Omega 2.0 Superior Lado Cebolão



494mm x 58mm

588 / Omega 2.0 Inferior Lado Retorno

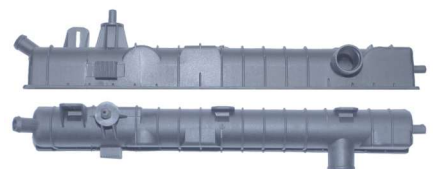

494mm x 58mm

589 / Omega 2.2 / 4.1 Inferior Lado Retorno

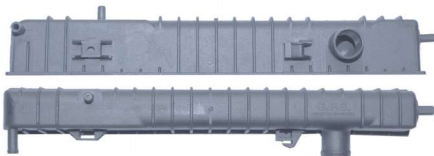

494mm x 58mm

590 / Omega 2.2 / 4.1



494mm x 58mm

591 / Omega Australiano C/ Elemento Óleo Aberto



451mm x 58mm

592 / Omega Australiano S/ Elemento Óleo Fechado



451mm x 58mm

593 / Opala / Chevette



417mm x 55mm

595 / Omega Australiano Moderno Inferior



451mm x 58mm

600 / S10 Brasado Diesel C/ Bico



410mm x 48mm

610 / S10 Brasado Gasolina Inferior



410mm x 48mm

620 / S10 Brasado Tampa



410mm x 48mm

621 / S10 Brasado Diesel Inferior Mangueira LE



410mm x 48mm

630 / S10 Diesel Inferior Bocal Grosso



418mm x 50mm

640 / S10 Gasolina Inferior Bocal Fino



418mm x 50mm

646 / S10 2013> Diesel Inferior Automatico P/ Sensor no Meio



656mm x 48mm

647 / S10 2013> Diesel Inferior Automatico



656mm x 48mm

649 / S10 2013> Flex Inferior Manual Trava Elemento



656mm x 48mm

650 / S10 Tampa Superior



418mm x 50mm

651 / S10 Pitbull Diesel Larga C/ Bico



418mm x 57mm

652 / S10 Pitbull Diesel Larga S/ Bico



418mm x 57mm

653 / S10 2013> Superior Tampa Manual C/ Retorno



656mm x 48mm

654 / S10 2013> Diesel Inferior Manual



656mm x 48mm

655 / S10 2013> Superior Automatico C/ Retorno



656mm x 48mm

656 / S10 2013> Flex Inferior Automatica



656mm x 48mm

657 / S10 2013> Flex Inferior Manual



656mm x 48mm

658 / S10 2013> Superior Manual C/ Sangrador



656mm x 48mm

660 / Vectra Modelo Antigo



408mm x 56mm

661 / Vectra Modelo Antigo Inferior



408mm x 56mm

662 / S10 2013> Diesel Inferior Manual Trava Elemento



656mm x 48mm

663 / S10 2013> Diesel Inferior Manual P/ Sensor

656mm x 48mm

664 / S10 2013> Diesel Inferior Automatico P/ Sensor

656mm x 48mm

665 / S10 2013> Diesel Inferior Manual P/ Sensor no Meio

656mm x 48mm

670 / Vectra Cebolão S/ Ar

378mm x 41mm

674 / S10 Nova 2013> Tampa Superior Manual S/Retorno

656mm x 48mm

680 / Vectra Inferior C/ Ar

374mm x 54mm

685 / Vectra Inferior S/ Ar

378mm x 41mm

690 / Vectra Superior C/ Ar C/ Porca Injetada

374mm x 55mm

700 / Vectra Superior C/ Ar Cebolão Fechado

374mm x 54mm

701 / Vectra Superior C/ Ar 1 Porca Injetada

374mm x 54mm

702 / Onix Geracao 3 Passag. 2020 / 2021 1.0 3Cilindros

400mm x 33mm

703 / Onix Geracao 3 Motorista 2020 / 2021 1.0 3Cilindros

400mm x 33mm

704 / Onix Superior Manual 20/25

430mm x 43mm

705 / Onix Turbo Inferior Automático 20/25

430mm x 43mm

706 / Onix 1.0 Inferior Turbo Manual 20/23

430mm x 43mm

707 / Tracker 1.0 1.2 C/ Ar 20/23

460mm x 43mm

708 / Tracker 1.0 1.2 C/ Ar Automático 20/23

460mm x 43mm

709 / Tracker 1.0 1.2 C/ Ar Manual 20/23

460mm x 43mm

710 / Zafira / Vectra Novo Bico Largo



395mm x 55mm

711 / Onix Turbo Superior



430mm x 42mm

712 / Zafira / Vectra Novo Largo Fechada



395mm x 55mm

713 / Zafira / Vectra Largo Similar Visconde Fechada



395mm x 55mm

719 / Zafira Novo 2009> Lisa Mangueira na Ponta



395mm x 55mm

720 / Zafira / Vectra Novo Largo Sangrador

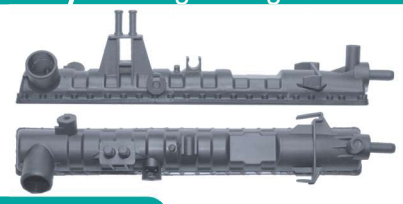

395mm x 55mm

721 / Zafira Novo 2009> Mangueira na Ponta

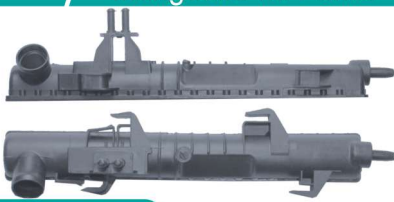

395mm x 55mm

722 / Zafira Novo 2009> Mangueira no Meio C/ Elemento de Óleo

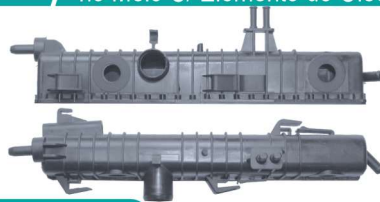

395mm x 55mm

723 / Zafira Novo 2009> Mangueira no Meio S/ Elemento de Óleo

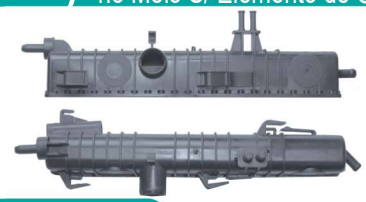

395mm x 55mm

724 / Cobalt Lado Retorno Similar Denso



378mm x 38mm

725 / Cobalt Lado Sangrador Similar Denso



378mm x 38mm

726 / Spin / Cobalt Superior Automatico



394mm x 31mm

727 / Spin / Cobalt Inferior Automático



394mm x 42mm

728 / Captiva 2008> Superior Automático



526mm x 63mm

729 / Captiva 2008> Inferior Automático



526mm x 63mm

7801 / Tracker Inferior C/ Elemento



544mm x 47mm

7802 / Tracker Superior Mangueira LE



544mm x 47mm

7899 / Spin/Cobalt/Prisma Superior



410mm x 44mm

7900 / Spin/Cobalt/Prisma
Inferior AT



403mm x 44mm

7901 / Spin/Cobalt/Prisma
Inferior MT



403mm x 44mm

7977 / Astra Zafira Similar
Visconde Superior

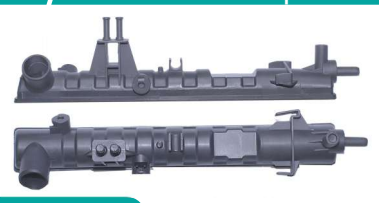

396mm x 56mm

7978 / Astra Zafira Similar
Visconde Inferior AT



394mm x 56mm

QUALIDADE E EFICÁCIA

RADIADORES, SOLDAS E
ACESSÓRIOS



SAIBA MAIS SOBRE NÓS



730 / Fox / Golf / Polo / A3



415mm x 42mm

731 / Fox / Golf / Polo / A3 Inferior



415mm x 42mm

740 / Gol G3 Inferior C/ Cano



343mm x 48mm

750 / Gol G3 Inferior S/ Cano



343mm x 48mm

760 / Gol G3 Superior



343mm x 48mm

761 / Gol G5 Similar Visconde Superior Fechado



420mm x 41mm

762 / Gol G5 Similar Visconde Superior Aberto



420mm x 41mm

763 / Gol G5 Similar Visconde Inferior



420mm x 41mm

764 / Gol G5 Superior Lado Mangueira Cebolão Fechado



415mm x 42mm

765 / Gol G5 Superior Lado Mangueira Cebolão Aberto



415mm x 42mm

766 / Gol G5 Inferior Lado Retorno



415mm x 42mm

767 / Golf / Cross Fox Space Fox Inferior



415mm x 42mm

768 / Gol G5 Similar Denso Inferior



416mm x 38mm

769 / Gol G5 Similar Denso Superior



416mm x 38mm

770 / Gol 87 Inferior



340mm x 45mm

780 / Gol 87 Superior



340mm x 45mm

790 / Gol Bola Canelado C/ Ar Superior Turbo



338mm x 55mm

791 / Gol Bola Canelado C/ Ar Inferior Turbo C/ Cano



338mm x 55mm

792 / Gol Bola Canelado C/ Ar Inferior Turbo S/ Cano

338mm x 55mm

800 / Gol Bola Canelado S/ Ar

340mm x 39mm

801 / Gol Bola Inferior S/ Ar Canelado C/ Cano

340mm x 39mm

802 / Gol Bola Inferior S/ Ar Canelado S/ Cano

340mm x 39mm

810 / Gol Bola Inferior C/ Ar C/ Cano

332mm x 60mm

820 / Gol Bola Inferior C/ Ar S/ Cano

332mm x 60mm

830 / Gol Bola Inferior C/ Cano

342mm x 38mm

840 / Gol Bola Inferior S/ Cano

342mm x 38mm

850 / Gol Bola Superior C/ Ar

332mm x 60mm

860 / Gol Bola Superior S/ Ar

342mm x 38mm

870 / Golf Mexicano

376mm x 46mm

871 / Golf Mexicano Inferior C/ Cebolão

376mm x 46mm

880 / Kombi Cebolão

415mm x 42mm

890 / Kombi Mangueira Ponta

415mm x 42mm

900 / Logus C/ Ar Lado Bico

378mm x 59mm

910 / Logus C/ Ar Lado Cebolão

378mm x 59mm

920 / Logus / Pointer / Escort Inferior S/ Ar Cebolão

322mm x 36mm

930 / Logus / Pointer / Escort Superior S/ Ar Bico

322mm x 36mm

940 / Passat

342mm x 47mm

950 / Polo Alemão Superior

377mm x 47mm

951 / Polo Alemão Inferior C/ Cebolão

377mm x 47mm

952 / Polo Alemão Inferior S/ Cebolão

377mm x 47mm

953 / Polo / Golf Antigo Superior Curto

322mm x 48mm

954 / Polo / Golf Antigo Inferior Curto

322mm x 48mm

960 / Santana Inferior

322mm x 48mm

970 / Santana Superior

322mm x 48mm

980 / Santana / Versailles 4 Saídas

322mm x 48mm

984 / UP Superior Similar Valeo

360mm x 42mm

985 / Santana / Versailles S/ Respiro

322mm x 48mm

986 / Up Inferior Similar Valeo

360mm x 42mm

987 / Up TSI Inferior Similar Behr

275mm x 40mm

988 / Up TSI Superior Similar Behr

275mm x 40mm

7568 / Golf/Passat/Tiguan/A3 A3/TT Superior

453mm x 40mm

7569 / Golf/Passat/Tiguan/A3 A3/TT Superior

453mm x 40mm

7571 / Golf/Passat/Tiguan/A3 A3/TT Similar Visconde

453mm x 40mm

7588 / A3 / Jetta / Passat

455mm x 47mm



QUALIDADE E EFICÁCIA

RADIADORES, SOLDAS E
ACESSÓRIOS



SAIBA MAIS SOBRE NÓS

990 / Civic Medio



675mm x 32mm

991 / Civic Grande



679mm x 32mm

992 / Civic Comprido Inferior Automático



678mm x 39mm

993 / Civic Comprido Inferior Manual



678mm x 39mm

994 / Civic 2013>2018 Superior



698mm x 32mm

1000 / Civic Largo C/ Ar



368mm x 47mm

1010 / Civic



370mm x 32mm

1011 / Civic Inferior C/ Ar e S/ Ar S/ Elemento de Óleo



370mm x 48mm

1012 / Civic Inferior C/ Ar e S/ Ar C/ Elemento de Óleo



370mm x 48mm

1015 / New Civic Superior



698mm x 47mm

1016 / New Civic Inferior



698mm x 47mm

1170 / Fit Superior



400mm x 47mm

1171 / Fit Inferior Aberto



400mm x 47mm

1172 / Fit Inferior Fechado



400mm x 47mm

1175 / City / New Fit Superior



754mm x 34mm

1176 / City / New Fit Inferior Manual



755mm x 40mm

1178 / Fit / City Superior 2014/2019



635mm x 31mm

1179 / Fit / City Inferior 2014/2019



638mm x 38mm

1180 / Accord Superior Largo



697mm x 47mm

1181 / Accord Superior



707mm x 40mm

1182 / Accord Superior Fino



697mm x 32mm

1183 / Accord Inferior C/ Elemento



706mm x 49mm

1184 / Accord Inferior S/ Elemento



706mm x 49mm

1187 / HRV Entrada da Água Superior



695mm x 31mm

1188 / HRV Saída da Água Inferior



695mm x 40mm

1276 / City / New Fit Inferior AT



755mm x 40mm

7010 / Civic 1.5 Turbo 17/18 Lado Motorista



463mm x 40mm

7030 / Civic 1.5 Turbo 18 Inferior



463mm x 44mm

7040 / Civic 1.5 Turbo 16/17 Superior



463mm x 39mm

7061 / Civic 1.5 Turbo 16/17 Inferior



463mm x 39mm

7712 / CRV 07/09 Superior



755mm x 48mm

1090 / Sprinter Inferior



434mm x 60mm

1100 / Sprinter 310 Superior

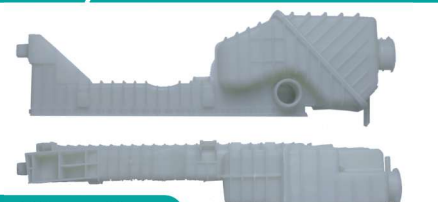

434mm x 60mm

1110 / Sprinter 313 / CDI

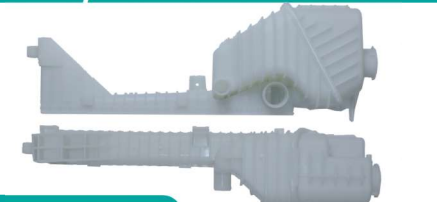

434mm x 60mm

1129 / Sprinter nova 2013>
Lado Retorno



415mm x 50mm

1152 / Sprinter nova 2013>
Lado Sangrador



415mm x 50mm

40000 / Classe A
Lado Dreno



390mm x 42mm

40001 / Classe A
Inferior



390mm x 42mm

7852 / Evoque Freelander LE

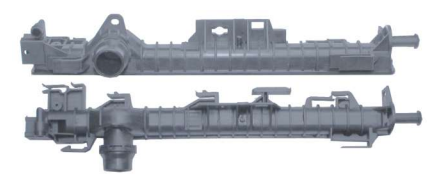

470mm x 42mm

1033 / Tucson/Sportage Superior C/ Elemento de Oleo

466mm x 46mm

1034 / Tucson/Sportage Inferior

466mm x 46mm

1038 / Tucson/Sportage Superior S/ Elemento de Oleo

466mm x 46mm

1106 / Hb20 Turbo 1.0 12V 20/23 C/Ar Manual LD

393mm x 45mm

1107 / Hb20 Turbo 1.0 12V 20/23 C/Ar Manual LE

393mm x 45mm

1111 / Hb20 Superior Manual

391mm x 34mm

1112 / Hb20 Inferior Manual

391mm x 34mm

1113 / Hb20 Superior Auto

392mm x 46mm

1114 / Hb20 Inferior Auto

392mm x 46mm

1115 / Ix35 Inferior Manual

492mm x 46mm

1116 / Hb20 Inferior Manual Larga

392mm x 46mm

1117 / I30 / Cerato Superior Manual

458mm x 46mm

1118 / I30 / Cerato Superior Automatica

458mm x 46mm

1119 / I30 / Cerato Inferior

458mm x 46mm

1135 / Tucson Lisa Superior Fechado Manual

473mm x 46mm

1136 / Tucson Lisa Superior Aberto Automatico

473mm x 46mm

1137 / Tucson Lisa Inferior

473mm x 46mm

1138 / Ix35 Superior

492mm x 46mm

1139

Ix35 Inferior Automatica



492mm x 46mm

1140

H-100 Superior



592mm x 53mm

1147

HR Inferior



590mm x 58mm

1160

HR Superior



590mm x 58mm

7929

Santa Fé 3.3 / Sorento Inferior Automático



491mm x 46mm

7935

Azera / Sonata 06/11 AT LD



491mm x 47mm

7968

Santa Fé 3.5 Superior



491mm x 46mm

7969

Santa Fé 3.5 Inferior Automático



491mm x 46mm

7970

Santa Fé 3.5 Inferior Manual



491mm x 46mm

7980

Santa Fé 3.3 / Sorento Superior



491mm x 46mm

7992

Santa Fé 3.5 / IX35 V6 10/16 Inferior MT



490mm x 45mm

8012

Santa Fé 3.5 / IX35 V6 10/16 Inferior AT



490mm x 45mm

CAIXAS KIA

7991

Picanto 06 / 11 Superior Automático



408mm x 44mm

7992

Sportage 12> Inferior MT



490mm x 45mm

8012

Sportage 12> Inferior AT



490mm x 45mm

1144 / Pajero Superior



621mm x 55mm

1145 / Pajero Sport Superior



659mm x 54mm

1146 / Pajero Sport Inferior
2.5 / 2.8



659mm x 54mm

1150 / Pajero TR4 / Full Superior



678mm x 48mm

1151 / Pajero TR4 / Full Inferior



678mm x 48mm

1154 / L200 Superior Pino Perto



697mm x 50mm

1155 / L200 Superior Pino Longe



697mm x 50mm

1156 / L200 Inferior Pino Perto



697mm x 50mm

7440 / Outlander 2015> Gasolina
2.4 / 3.0 Superior



715mm x 35mm

7442 / Outlander 2.2 Diesel
Superior 2018/2022



710mm x 45mm

7443 / Outlander 2015> Diesel
2.2 Inferior



710mm x 45mm

7539 / L200 Triton 2.4 Diesel AT
C/ 2 Retorno 2018>

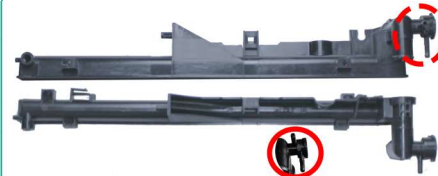

667mm x 45mm

7946 / Outlander/ASX/Lancer
09/14 2.0/2.4 Inferior

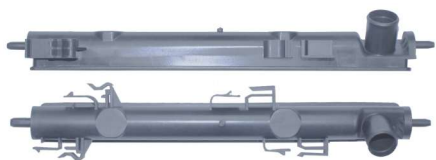

431mm x 44mm

7947 / Outlander / ASX / Lancer
09/14 superior



431mm x 46mm

7951 / L200 Triton/Dakar Diesel Auto
2008> Inferior Bocal Reto



660mm x 47mm

7952 / L-200 Triton/ Pajero Dakar
Gasolina Aut 2008> Inf Bocal Torto



660mm x 47mm

7953 / L200 Triton / Dakar Diesel
Manual 2008> Inferior Bocal Reto



660mm x 47mm

7979 / L-200 Triton/ Pajero Dakar Gasolina
Manual 2008> Inf Bocal Torto



660mm x 47mm

7981 / L200 Triton / Dakar Gasolina / Diesel Manual 08> Superior



660mm x 47mm

CAIXAS NISSAN

1059 / Livina Superior



612mm x 33mm

1073 / Kicks 1.6 16/19 Mangueira na Ponta



410mm x 30mm

1074 / Kicks 1.6 16/19 Mangueira no Meio



410mm x 30mm

1141 / Frontier 2009> Inferior S/ Elemento de Oleo



714mm x 52mm

1142 / Frontier 2009> Inferior C/ Elemento de Oleo G



714mm x 52mm

1143 / Frontier 2009> Superior



712mm x 52mm

1148 / March / Versa Superior

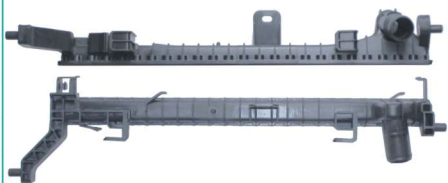

430mm x 31mm

1149 / March / Versa Inferior

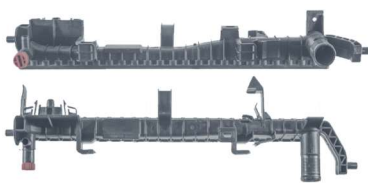

430mm x 31mm

1161 / Tiida Superior



612mm x 36mm

1162 / Tiida / Livina Inferior Manual



612mm x 50mm

1173 / Tiida / Livina Inferior AT



612mm x 50mm

1226 / Frontier Antiga C/ Retorno



698mm x 50mm

1227 / Frontier Antiga S/ Retorno



698mm x 50mm

1253 / Frontier 2009> Inferior C/ Elemento de Oleo P



714mm x 52mm

7742 / Sentra 07/12 2.0/2.5 Superior



698mm x 33mm

1040 / 206 Bico Fino



564mm x 42mm

1050 / 206 Bico Largo



564mm x 42mm

1051 / 206 Inferior C/ 1 Saída



564mm x 42mm

1052 / 206 Inferior C/ 2 Saídas



564mm x 42mm

1053 / 206 Inferior C/ 3 saídas



564mm x 42mm

1054 / 408 Novo/3008 C4 Lounge



563mm x 42mm

1055 / C4/Aircross
Similar Denso Inferior 10/18



561mm x 32mm

1056 / C4/Aircross
Similar Denso Superior



561mm x 32mm

1060 / 306



378mm x 42mm

1061 / 307 / C4 Superior
C/ Retorno



566mm x 47mm

1062 / 307 / C4 Inferior
S/ Retorno



566mm x 47mm

1082 / Reserv. 306 / 405 Gargalo
Curto Engate Rápido



379mm x 42mm

1084 / Reserv. Partner / Berlingo
Gargalo Engate Rápido



379mm x 42mm

1085 / Reserv. Partner / Berlingo
Gargalo Engate Arame



379mm x 42mm

1086 / Reserv. 306 / 405 Gargalo
Curto Bocal Liso P/ Abraçadeira



379mm x 42mm

1087 / Reserv. Partner / Berlingo Gargalo
Bocal Liso P/ Abraçadeira



379mm x 42mm

1088 / 307/C4 Similar
Denso Superior



567mm x 42mm

1089 / 307/C4 Similar Valeo
Superior



564mm x 42mm

1095 / 307/C4 Similar Denso Inferior



567mm x 42mm

1096 / 307/C4 Similar Valeo Inferior



564mm x 42mm

1098 / Jumpy / Expert Scudo 2020 LE



433mm x 43mm

1099 / Jumpy / Expert Scudo 2020 LD



433mm x 43mm

CAIXAS JAC

7916 / Jac 2 1.4/16V Manual Superior



590mm x 32mm

7918 / J3 1.4/16V 2011> Superior



623mm x 37mm

11805 / V260 2.0 2022



588mm x 63mm



**1063 / Duster
Mangueira na Ponta**



417mm x 42mm

**1064 / Duster
Mangueira no Meio**

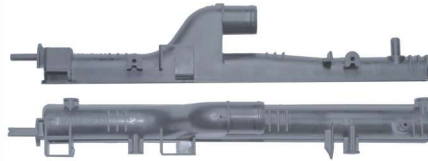

417mm x 42mm

**1065 / Scénic Superior
Elemento Fechado**



415mm x 42mm

**1066 / Scénic Superior
Elemento Aberto**



415mm x 42mm

1067 / Scénic Inferior



415mm x 42mm

1068 / Master Superior 2013>

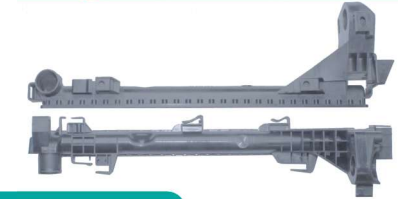

492mm x 40mm

**1069 / Master Inferior 2013>
Lado Retorno**

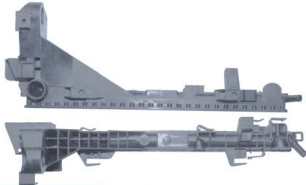

492mm x 40mm

**1070 / Megane/Logan/Clio
Sandero Inferior S/ Tubete**



415mm x 42mm

**1071 / Megane/Logan/Clio
Sandero Inferior C/ Tubete**



415mm x 42mm

**1072 / Clio Agulha Inferior
S/ Tubete**

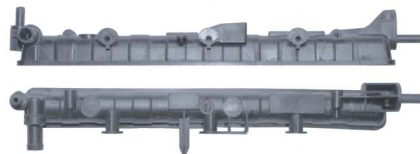

378mm x 42mm

1075 / Sandero C/ Bico



410mm x 34mm

1076 / Sandero S/ Bico



410mm x 34mm

**1077 / Kwid 1.0 12V Inferior
2017/2020**

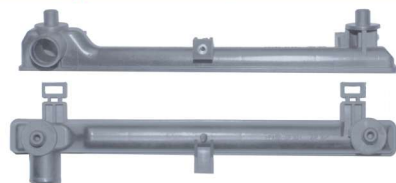

365mm x 34mm

**1078 / Kwid 1.0 12V Superior
2017/2020**

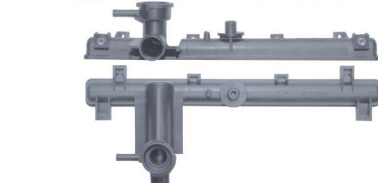

365mm x 34mm

**1079 / Logan/Sandero 1.0
2014 C/ Bico**



415 mm x 23 mm

1080 / Megane Superior



415mm x 42mm

1081 / Clio 1.6 Argentino

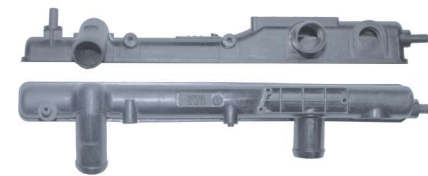

415mm x 42mm

**1097 / Logan/Sandero 1.0
2014**

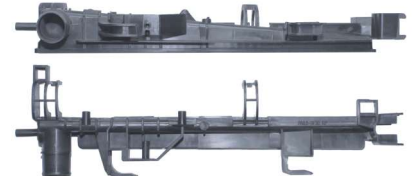

415 mm x 23 mm

1195 / Clio Agulha Superior



380mm x 42mm

1196 / Clio Agulha Inferior

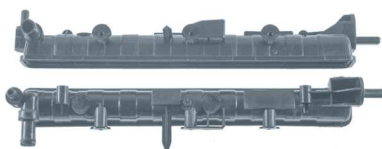

380mm x 42mm

CAIXAS SUZUKI

7800 / Vitara Superior
Mangueira LD



544mm x 47mm

7801 / Vitara Inferior
C/ Elemento



544mm x 47mm

7802 / Vitara Superior
Mangueira LE



544mm x 47mm

7955 / Vitara Inferior
S/ Elemento



544mm x 47mm

1120 / Corolla Largo Tampa

715mm x 45mm

1121 / Corolla Fino Tampa

657mm x 31mm

1122 / Corolla Lado Sangrador 2003 em Diante

370mm x 32mm

1123 / Corolla Lado Tampa 2003 em Diante

372mm x 39mm

1124 / Corolla Fina Superior C/ Elemento de Óleo 09/18

400mm x 40mm

1125 / Corolla Fina Inferior 09/18

400mm x 33mm

1126 / Corolla Superior 09/18

400mm x 40mm

1127 / Etios Superior

565mm x 33mm

1128 / Etios Inferior

565mm x 33mm

1190 / Hilux 3.0 Superior C/ Retorno

679mm x 48mm

1191 / Hilux 3.0 Inferior 2 Saídas S/ Elemento

679mm x 48mm

1192 / Camry Superior 4 Fixações Tampa

740mm x 33mm

1193 / Hilux Superior Tampa Mangueira Ponta

679mm x 48mm

1194 / Hilux Inferior Mangueira Ponta

679mm x 48mm

1197 / Hilux Inferior Sangrador C/ Elemento Aberto

679mm x 48mm

1198 / Hilux SW4 Superior Tampa Fina

660mm x 47mm

1199 / Hilux SW4 Superior Tampa Largo

660mm x 54mm

1201 / Hilux SW4 Inferior C/ Elemento Fechado

660mm x 47mm

1202 / Hilux SW4 Inferior C/ Elemento Aberto



660mm x 47mm

1203 / Hilux SW4 Inferior C/ Elemento Fechado



660mm x 53mm

1204 / Hilux SW4 Inferior C/ Elemento Aberto



660mm x 53mm

1207 / Hilux Turbo Curta Inferior



545mm x 55mm

1208 / Hilux Curta Superior C/ Retorno



545mm x 55mm

1209 / Hilux Aspirada Curta Inferior

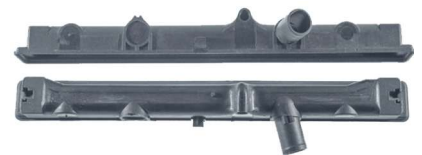

545mm x 55mm

1223 / Hilux Lado Retorno 2016>



675mm x 43mm

1224 / Hilux SW4 Superior Gasolina Mangueira LD



660mm x 47mm

1225 / Hilux SW4 Superior Gasolina Mangueira LD



660mm x 57mm

1242 / Hilux Inferior 2016>



675mm x 43mm

7738 / Empilhadeira Inferior Bocal Fino

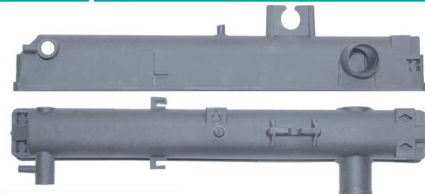

446mm x 58mm

7948 / Empilhadeira Superior Lado Motorista



447mm x 85mm

8301 / Empilhadeira Inferior Bocal Lado Esquerdo C/ Sangrador

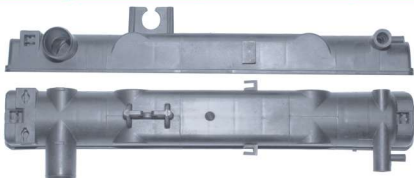

465mm x 68mm

8302 / Empilhadeira Inferior Bocal Lado Direito M



465mm x 68mm

8309 / Empilhadeira Superior Bocal Invertido



447mm x 85mm

9094 / Empilhadeira Inferior Bocal Lado Esquerdo G



445mm x 85mm

9095 / Empilhadeira Inferior Bocal Lado Direito G



445mm x 85mm

1028 / Nova C-3 Superior

415mm x 42mm

1029 / Nova C-3 Inferior

415mm x 42mm

1031 / C3 Superior

415mm x 42mm

1032 / C3 Inferior

415mm x 42mm

1035 / C3 S/ Cano

415mm x 42mm

1042 / DS3/DS4/Aircross/Peugeot Engate Rápido C/Retorno

560mm x 41mm

1043 / DS3/DS4/Aircross/Peugeot Engate Rápido S/Retorno

560mm x 41mm

1044 / DS3/DS4/Aircross/Peugeot Superior Rebaixada

560mm x 41mm

1045 / DS3/DS4/Aircross/Peugeot Inferior 2 Encaixes

560mm x 41mm

1046 / DS3/DS4/Aircross/Peugeot 208 Superior

563mm x 43mm

1047 / DS3/DS4/Aircross/Peugeot 208 Inferior 3 Encaixes

563mm x 43mm

1055 / Citroen/ Aircross Similar Denso Inferior 10/18

561mm x 31mm

1056 / Citroen/ Aircross Similar Denso Superior 10/18

561mm x 31mm