



CAIXAS

LINHA LEVE

LINHA LEVE

LINHA LEVE

LINHA LEVE

CENTRAL DE VENDAS

Alessandra (11) 95456-6290
Carla (11) 95796-0176
Evelyn (11) 95804-9330
Fabiana (11) 97895-9270
Jamile (11) 97895-8886
Ketlyn (11) 95824-7581

vendas@supersoldas.com.br
carla@supersoldas.com.br
evelyn@supersoldas.com.br
fabiana@supersoldas.com.br
jamil@supersoldas.com.br
ketlyn@supersoldas.com.br

10

Doblò Superior
Mangueira C/Ar



420mm x 42mm

15

Doblò Inferior C/Ar



420mm x 42mm

20

Ducato Inferior



427mm x 48mm

30

Ducato Superior



427mm x 48mm

40

Fiorino / Spazio Inferior



324mm x 46mm

50

Fiorino / Spazio Superior



324mm x 46mm

60

Marea Inferior



580mm x 45mm

70

Marea Superior



580mm x 45mm

75

Marea Superior
Largo Fechado



585mm x 59mm

76

Marea Inferior Largo



585mm x 59mm

77

Marea Superior
Largo Aberto



585mm x 59mm

80

Palio 1.5 Inferior

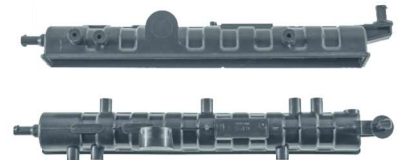

360mm x 46mm

90

Palio 1.5 Superior Bocal



360mm x 46mm

91

Palio 1.5 Superior Bocal
Cebolão Fechado

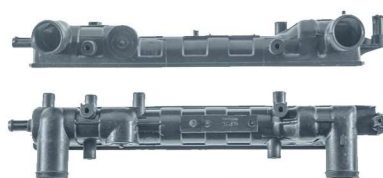

360mm x 46mm

100

Palio Fire Inferior
Canelado



392mm x 45mm

105

Palio Fire Canelado
Superior C/ Divisão



390mm x 42mm

110

Palio Fire Superior
Canelado

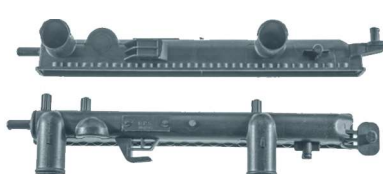

390mm x 41mm

120

Palio Fire Inferior
Liso



378mm x 42mm

130 / Palio Fire Superior Liso

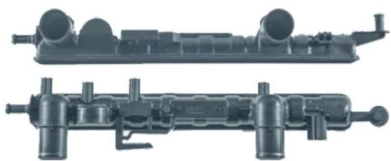

378mm x 42mm

135 / Palio Fire Superior Similar Visconde



390mm x 41mm

136 / Palio Fire Inferior Similar Visconde



390mm x 41mm

137 / Palio Fire Superior Similar Denso



377mm x 38mm

138 / Palio Fire Inferior Similar Denso



377mm x 38mm

140 / Palio Reservatório

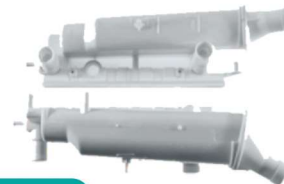

360mm x 42mm

141 / Palio 1.0 Inferior

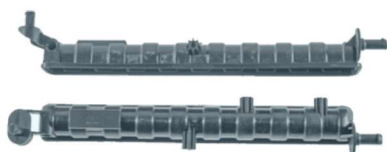

360mm x 42mm

145 / Toro Inferior 2018 1.8 16V



405mm x 31mm

146 / Toro Superior Lado Sangrador 2018 1.8 16V

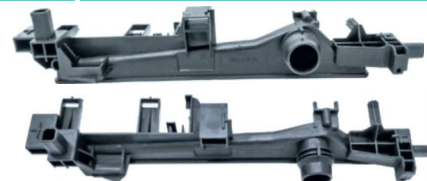

405mm x 28mm

147 / Renegade Inferior Diesel 2015>2019

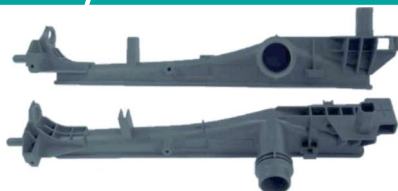

420mm x 39mm

148 / Renegade Superior Diesel 2015>2019

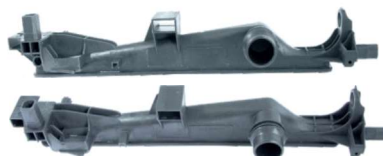

420mm x 39mm

150 / Tempra Inferior

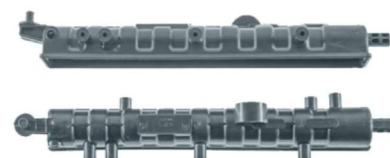

360mm x 46mm

151 / Toro Diesel Bocal Longo



421mm x 41mm

152 / Toro Diesel Bocal Curto

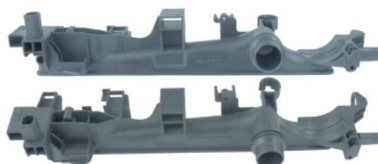

421mm x 41mm

160 / Tempra Superior

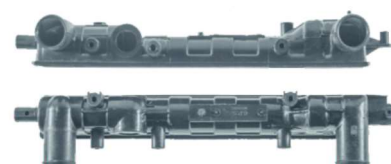

360mm x 46mm

170 / Tipo Inferior



386mm x 49mm

180 / Tipo Superior

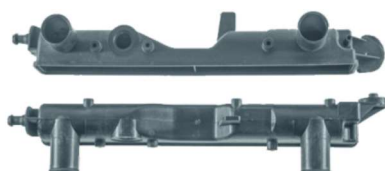

386mm x 49mm

189 / Uno Inferior Similar Denso



322mm x 37mm

190 / Uno Inferior

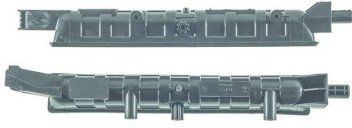

322mm x 47mm

191 / Uno Superior Fino

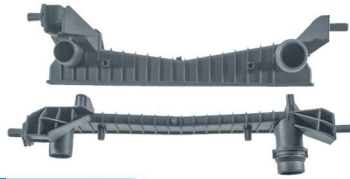

399mm x 24mm

192 / Uno Inferior Fino



399mm x 24mm

193 / Novo Uno/Palio/Siena/Mobi Sim. Denso S/Ret. 4Cilindros



379mm x 37mm

194 / Novo Uno/Palio/Siena/Mobi Sim. Denso C/Ret. 4Cilindros



379mm x 37mm

195 / Uno LX Argentino C/ Ar

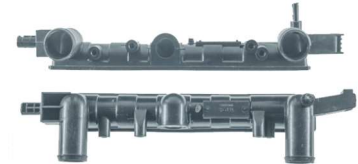

322mm x 47mm

200 / Uno Reservatório

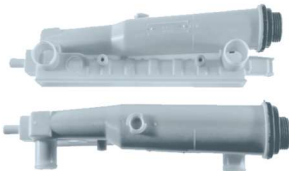

322mm x 47mm

202 / Uno Reservatório Similar Denso

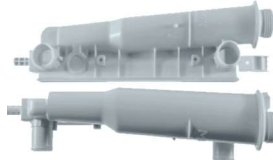

322mm x 37mm

203 / Punto 1.4 Superior Similar Denso



378mm x 37mm

204 / Punto 1.4 Inferior Similar Denso



378mm x 37mm

205 / Stilo Superior 2 Bocais



423mm x 54mm

206 / Stilo Inferior C/ Respiro



423mm x 54mm

207 / Stilo Inferior S/ Respiro



423mm x 54mm

7350 / Mobi / Uno 1.0 6V 2017 2019 Lado Carona



406mm x 33mm

7460 / Mobi / Uno 1.0 6V 2017 2019 Lado Motorista



406mm x 33mm

8015 / Argo/Cronos Superior 8V/16V 1.3/1.8



404mm x 30mm

8016 / Argo/Cronos Inferior 8V/16V 1.3/1.8



404mm x 30mm

8361 / Nova Strada 1.3 Flex



407mm x 31mm

CAIXAS FIAT

8370 / Nova Strada 1.4 20/21
Lado Mangueira



407mm x 33 mm

8380 / Strada 1.4 20/21
Com Ar



407mm x 33mm

8421 / Toro 2.4 Jeep Compass
2.0 / 2.4 Superior



420mm x 41mm

8422 / Toro 2.4 Jeep Compass
2.0 / 2.4 Inferior



420 mm x 41 mm

CAIXAS BMW

7623 / 116 / 120 / 128-I / Z4
X1 09> Superior



475mm x 48mm

209 / Corcel / Pampa / Belina



325mm x 47mm

210 / Escort 86



326mm x 48mm

220 / Escort / Verona Inferior Cebolão



323mm x 35mm

230 / Escort / Verona Superior



323mm x 35mm

240 / Escort Zetec Inferior



372mm x 62mm

241 / Escort Zetec Superior

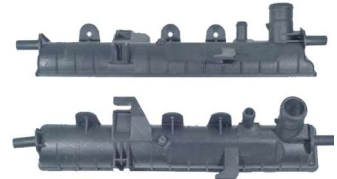

372mm x 62mm

242 / Fiesta / Courier - Zetec Lado Mangueira



360mm x 42mm

250 / Fiesta / Courier Inferior C/ Bico



360mm x 42mm

260 / Fiesta Curto S/ Ar

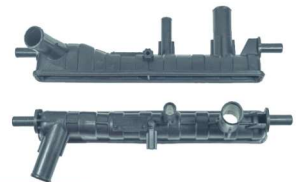

305mm x 42mm

261 / Fiesta Inferior Curto S/ Ar



305mm x 42mm

270 / Fiesta Largo C/ Ar



365mm x 48mm

280 / Fiesta Longo C/ Ar



360mm x 42mm

281 / Fiesta Longo Inferior C/ Ar C/ Mangueira na Ponta

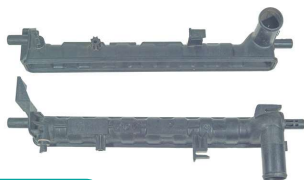

360mm x 42mm

282 / Fiesta Longo Inferior C/ Ar S/ Mangueira

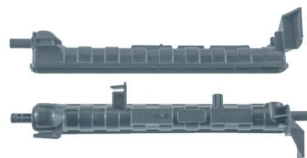

360mm x 42mm

290 / Fiesta Novo / Courier Ecosport Inferior

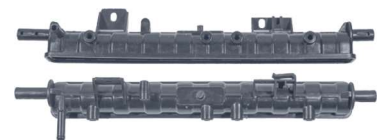

360mm x 42mm

300 / Fiesta Novo / Courier Ecosport Superior



360mm x 43mm

302 / Novo Ecosport / Ka New Fiesta C/ Retorno



562mm x 42mm

303 / Novo Ecosport / Ka New Fiesta S/ Retorno



562mm x 42mm

304 / New Fiesta / Ecosport / Ka Inferior

562mm x 42mm

305 / F-250 / F-350 / F-4000 Superior G

780mm x 76mm

306 / F-250 / F-350 / F-4000 Inferior G

780mm x 76mm

307 / F-250 / F-350 / F-4000 Superior P

772mm x 76mm

308 / F-250 / F-350 / F-4000 Inferior P

772mm x 76mm

310 / Ka Brazado Inferior

365mm x 45mm

311 / Ecosport Magueira no Meio S / Retorno - **30MM**

560mm x 34mm

312 / Ecosport Magueira no Meio

561mm x 41mm

313 / Ecosport Magueira no Meio C / Retorno - **30MM**

560mm x 34mm

314 / Ecosport Magueira no Meio C / Retorno

560mm x 34mm

315 / Ranger Superior 2013> / Troller

658mm x 45mm

316 / Ranger Superior 2013> C / Retorno / Troller

658mm x 45mm

317 / Ranger Superior 2013> S / Retorno

658mm x 45mm

318 / Ecosport 18/19 C/ Mangueira na Ponta

725mm x 35mm

319 / Ecosport 18/19 C/ Mangueira no Meio

725mm x 35mm

320 / Ka Largo Bocal C/Ar

365mm x 48mm

322 / Ecosport Magueira no Meio S / Retorno - **24MM**

562mm x 34mm

323 / Ecosport Magueira no Meio C / Retorno - **24MM**

560mm x 34mm

330 / Ka Largo Bocal S/Ar

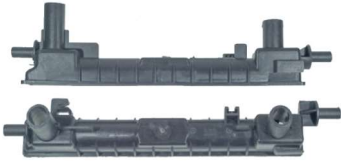

365mm x 48mm

340 / Ka Similar Valeo

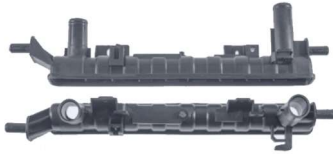

360mm x 42mm

341 / Ka Similar Valeo Inferior C/ Retorno

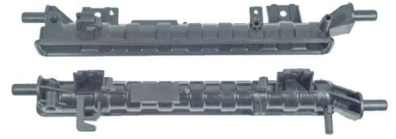

360mm x 42mm

342 / Ka Similar Valeo Inferior S/ Retorno



360mm x 42mm

343 / Focus C/ 02 Retornos

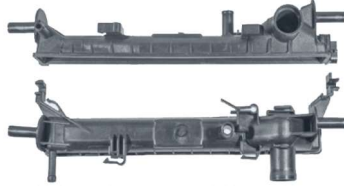

365mm x 45mm

344 / Focus Lado Sangrador



365mm x 45mm

345 / Ranger C/ Respiro



438mm x 45mm

346 / Ranger S/ Respiro



438mm x 45mm

365 / Focus C/ 01 Retorno



365mm x 45mm

366 / Focus S/ Retorno

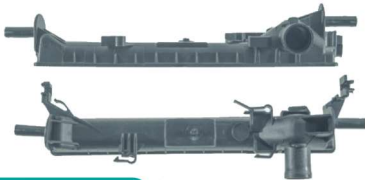

365mm x 45mm

367 / New Focus Lado Sangrador



370mm x 31mm

368 / New Focus Lado Entrada



370mm x 31mm

7707 / Focus 2010 S/ Bico



389mm x 37mm

7708 / Focus 2010 C/ Bico



389mm x 37mm

7887 / Focus 2010 S/ Bico Lisa



389mm x 37mm

7888 / Focus 2010 C/ Bico Lisa



389mm x 37mm

7937 / Ecosport / Fiesta 03/10 AT S/ Bocal

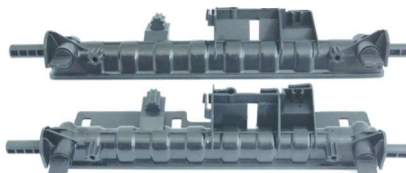

361mm x 43mm

7938 / Ecosport / Fiesta 03/10 AT Lado Bocal



361mm x 43mm

348 / Agile C/ Retorno

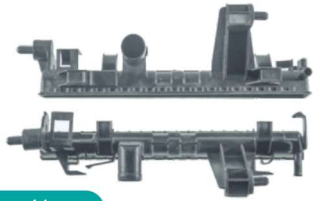

390mm x 41mm

349 / Agile Mangueira na Ponta



390mm x 41mm

350 / Astra Bico



390mm x 40mm

351 / Astra 95 C/ 2 Cebolões



367mm x 47mm

353 / Astra Novo Mangueira na Ponta



389mm x 32mm

354 / Astra Novo Lado Retorno



389mm x 32mm

355 / Astra Sangrador Similar Visconde

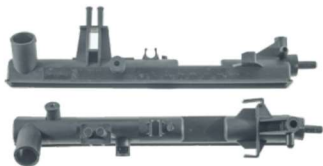

390mm x 40mm

356 / Astra Bico Similar Visconde



390mm x 40mm

357 / Astra Novo Mangueira na Ponta Similar Visconde

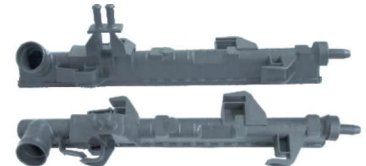

389mm x 32mm

358 / Astra Novo Lado Retorno Similar Visconde

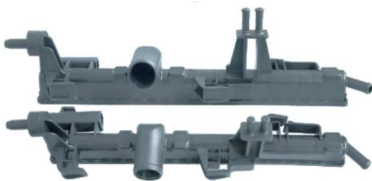

389mm x 32mm

360 / Astra Sangrador



390mm x 40mm

361 / Blazer 4.3 Elemento Óleo Aberto



417mm x 57mm

362 / Blazer 4.3 Elemento Óleo Fechado



417mm x 57mm

363 / Blazer Tampa Elemento Óleo Fechado



417mm x 57mm

364 / Blazer Tampa Elemento Óleo Aberto



417mm x 57mm

370 / Celta Inferior C/ Ar

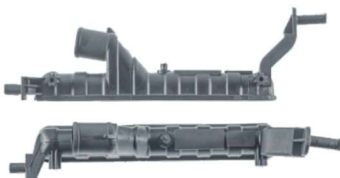

285mm x 42mm

380 / Celta Inferior S/ Ar



285mm x 42mm

390 / Celta / Prisma C/ Retorno



323mm x 42mm

400 / Celta / Prisma S/ Retorno



324mm x 43mm

401 / Celta / Prisma 2 Mangueiras



323mm x 43mm

402 / Agile C/Retorno Similar Visconde



390mm x 42mm

403 / Agile Mangueira na Ponta Similar Visconde



392mm x 42mm

404 / Zafira Nova 09> Mang. Meio C/ Elemento Similar Visconde

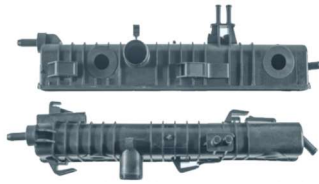

395mm x 55mm

405 / Zafira Nova 09> Mang. Meio S/ Elemento Similar Visconde



395mm x 55mm

410 / Celta Reservatório



285mm x 42mm

420 / Corsa Canelado

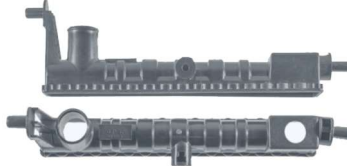

298mm x 37mm

425 / Corsa Canelado Inferior



298mm x 37mm

430 / Corsa Inferior C/ Ar



280mm x 48mm

440 / Corsa Liso Inferior



285mm x 42mm

450 / Corsa Liso Superior Cebolão Aberto



285mm x 42mm

460 / Corsa Liso Superior Cebolão Fechado



285mm x 42mm

470 / Corsa / Montana (bocal)

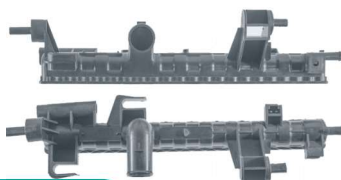

390mm x 40mm

471 / Corsa / Montana Bocal Similar Visconde



390mm x 40mm

472 / Corsa / Montana Bocal Importada

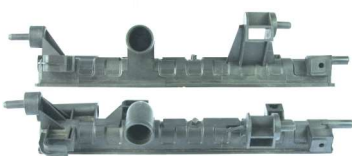

379mm x 40mm

480 / Corsa / Montana Sangrador



390mm x 40mm

481 / Corsa / Montana Sangrador Similar Visconde

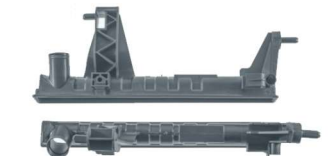

390mm x 40mm

482 / Corsa / Montana Sangrador Importada



379mm x 40mm

490 / Corsa Superior C/ Ar Cebolão Aberto



280mm x 48mm

500 / Corsa Superior C/ Ar Cebolão Fechado



280mm x 48mm

501 / Corsa Classic Superior S/ Retorno 2010>

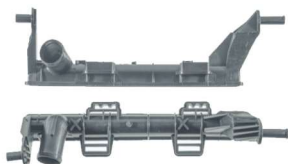

304mm x 37mm

502 / Corsa Classic Inferior C/ Retorno 2010>

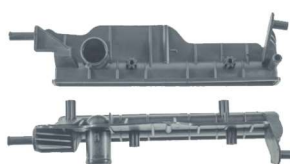

304mm x 37mm

503 / Onix/Sonic/Novo Prisma C/ Retorno



378mm x 32mm

504 / Onix/Sonic/Novo Prisma S/ Retorno



378mm x 32mm

505 / Cruze Inferior C/ Elemento

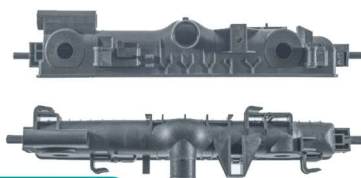

408mm x 48mm

506 / Cruze Inferior S/ Elemento

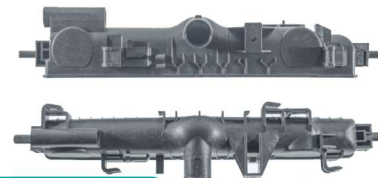

408mm x 48mm

507 / Cruze Superior Lado Sangrador



408mm x 48mm

510 / Meriva Bico

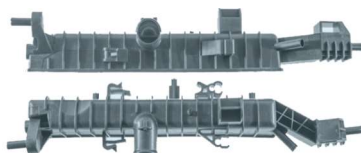

375mm x 55mm

520 / Meriva Sangrador



375mm x 55mm

530 / Monza Bico



417mm x 48mm

535 / Monza Brasado Inferior

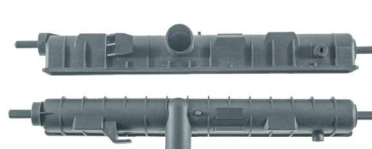

408mm x 47mm

540 / Monza Cebolão

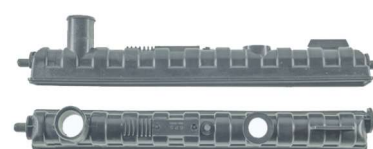

417mm x 48mm

550 / Monza / Kadett Brasado Cebolão Aberto



410mm x 48mm

560 / Monza / Kadett Brasado Cebolão Fechado



410mm x 48mm

570 / Monza / Kadett Inferior Fino



416mm x 37mm

580 / Monza / Kadett Superior
Fino Aberto



416mm x 37mm

582 / Monza / Kadett Superior
Fino Fechado

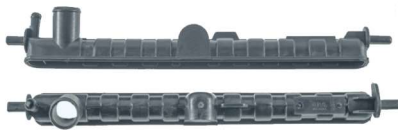

416mm x 37mm

583 / Omega 3.0 Inferior
C/ Elemento de Óleo



484mm x 60mm

584 / Omega 3.0 Inferior
S/ Elemento de Óleo



484mm x 60mm

585 / Omega 3.0 Superior
Lado Cebolão



484mm x 60mm

587 / Omega 2.0 Superior
Lado Cebolão



494mm x 58mm

588 / Omega 2.0 Inferior
Lado Retorno

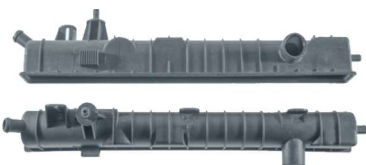

494mm x 58mm

589 / Omega 2.2 / 4.1 Inferior
Lado Retorno



494mm x 58mm

590 / Omega 2.2 / 4.1



494mm x 58mm

591 / Omega Australiano
C/ Elemento Óleo Aberto



451mm x 58mm

592 / Omega Australiano
S/ Elemento Óleo Fechado

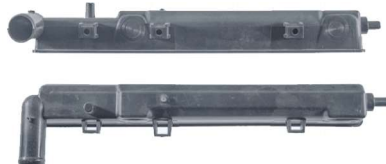

451mm x 58mm

593 / Opala / Chevette



417mm x 55mm

595 / Omega Australiano
Moderno Inferior



451mm x 58mm

600 / S10 Brasado Diesel
C/ Bico



410mm x 48mm

610 / S10 Brasado Gasolina
Inferior



410mm x 48mm

620 / S10 Brasado Tampa



410mm x 48mm

621 / S10 Brasado Diesel
Inferior Mangueira LE



410mm x 48mm

630 / S10 Diesel
Inferior Bocal Grosso

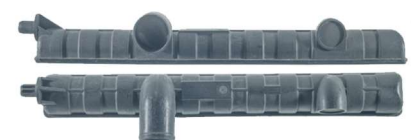

418mm x 50mm

640 / S10 Gasolina Inferior Bocal Fino

418mm x 50mm

646 / S10 2013> Diesel Inferior Automatico P/ Sensor no Meio

656mm x 48mm

647 / S10 2013> Diesel Inferior Automatico

656mm x 48mm

649 / S10 2013> Flex Inferior Manual Trava Elemento

656mm x 48mm

650 / S10 Tampa Superior

418mm x 50mm

651 / S10 Pitbull Diesel Larga C/ Bico

418mm x 57mm

652 / S10 Pitbull Diesel Larga S/ Bico

420mm x 58mm

653 / S10 2013> Superior Tampa Manual C/ Retorno

656mm x 48mm

654 / S10 2013> Diesel Inferior Manual

656mm x 48mm

655 / S10 2013> Superior Automático C/ Retorno

656mm x 48mm

656 / S10 2013> Flex Inferior Automática

656mm x 48mm

657 / S10 2013> Flex Inferior Manual

656mm x 48mm

658 / S10 2013> Superior Manual C/ Sangrador

656mm x 48mm

660 / Vectra Modelo Antigo

408mm x 56mm

661 / Vectra Modelo Antigo Inferior

408mm x 56mm

662 / S10 2013> Diesel Inferior Manual Trava Elemento

656mm x 48mm

663 / S10 2013> Diesel Inferior Manual P/ Sensor

656mm x 48mm

664 / S10 2013> Diesel Inferior Automatico P/ Sensor

656mm x 48mm

665

S10 2013> Diesel Inferior Manual P/ Sensor no Meio



656mm x 48mm

670

Vectra Cebolão S/ Ar

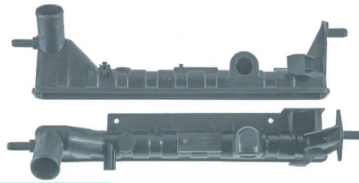

378mm x 41mm

674

S10 Nova 2013> Tampa Superior Manual S/Retorno



656mm x 48mm

680

Vectra Inferior C/ Ar



374mm x 54mm

685

Vectra Inferior S/ Ar

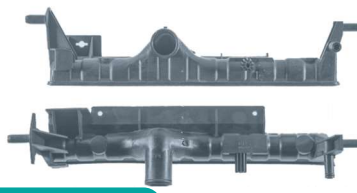

378mm x 41mm

690

Vectra Superior C/ Ar C/ Porca Injetada



374mm x 55mm

700

Vectra Superior C/ Ar Cebolão Fechado



374mm x 54mm

701

Vectra Superior C/ Ar 1 Porca Injetada



374mm x 54mm

702

Onix Geracao 2 Passag. 2020 / 2021 1.0 3Cilindros

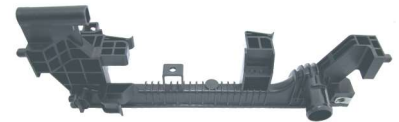

400mm x 33mm

703

Onix Geracao 2 Motorista 2020 / 2021 1.0 3Cilindros



400mm x 33mm

704

Onix 1.0 Superior Turbo



430mm x 43mm

705

Onix 1.0 Inferior Turbo Automatico



430mm x 43mm

706

Onix 1.0 Inferior Turbo Manual



430mm x 43mm

707

Onix 1.0 Superior Turbo



460mm x 43mm

708

Onix 1.0 Inferior Turbo Automatico



460mm x 43mm

709

Onix 1.0 Inferior Turbo Manual



460mm x 43mm

710

Zafira / Vectra Novo Bico Largo

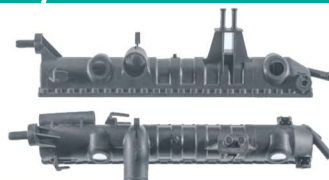

395mm x 55mm

719

Zafira Novo 2009> Lisa Mangueira na Ponta

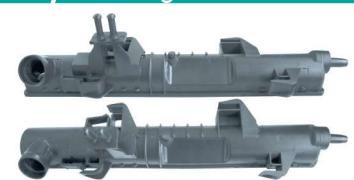

395mm x 55mm

720 / Zafira / Vectra Novo
Largo Sangrador

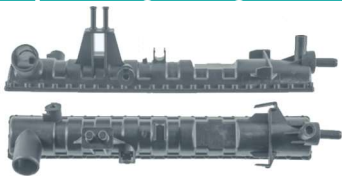

395mm x 55mm

721 / Zafira Novo 2009>
Mangueira na Ponta

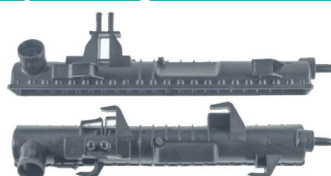

395mm x 55mm

722 / Zafira Novo 2009> Mangueira
no Meio C/ Elemento de Óleo

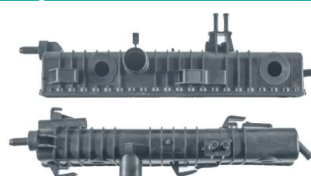

395mm x 55mm

723 / Zafira Novo 2009> Mangueira
no Meio S/ Elemento de Óleo



395mm x 55mm

724 / Cobalt Lado Retorno
Similar Denso



378mm x 38mm

725 / Cobalt Lado Sangrador
Similar Denso



378mm x 38mm

726 / Spin / Cobalt Superior
Automatico



394mm x 31mm

727 / Spin / Cobalt Inferior
Automatico



394mm x 42mm

728 / Captiva 2008>
Superior Automatico

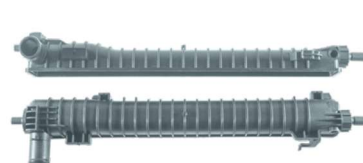

526mm x 63mm

729 / Captiva 2008>
Inferior Automatico

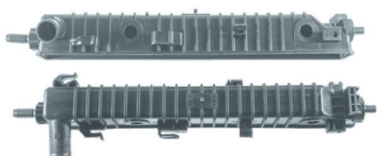

526mm x 63mm

7802 / Vitara / Tracker
Superior Mangueira LE



544mm x 47mm

7899 / Spin/Cobalt/Prisma
Superior

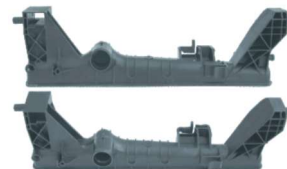

409mm x 44mm

7900 / Spin/Cobalt/Prisma
Inferior AT

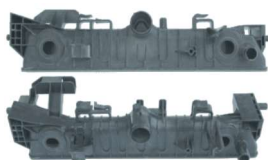

403mm x 44mm

7901 / Spin/Cobalt/Prisma
Inferior MT

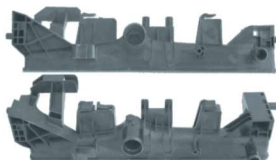

403mm x 44mm

7977 / Astra Zafira Similar
Visconde Superior

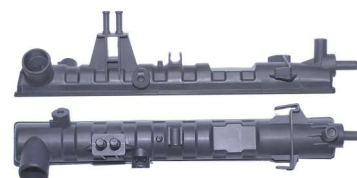

396mm x 56mm

7978 / Astra Zafira Similar
Visconde Inferior AT



394mm x 56mm

730 / Fox / Golf / Polo / Audi



415mm x 42mm

731 / Fox / Golf / Polo / Audi Inferior

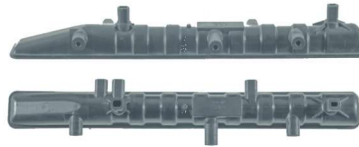

415mm x 42mm

740 / Gol G3 Inferior C/ Cano



343mm x 48mm

750 / Gol G3 Inferior S/ Cano

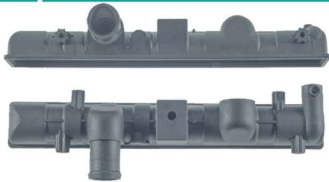

343mm x 48mm

760 / Gol G3 Superior

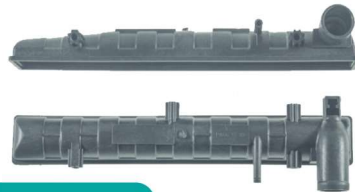

343mm x 48mm

761 / Gol G5 Similar Visconde Superior Fechado



420mm x 41mm

762 / Gol G5 Similar Visconde Superior Aberto



420mm x 41mm

763 / Gol G5 Similar Visconde Inferior



420mm x 41mm

764 / Gol G5 Superior Lado Mangueira Cebolão Fechado

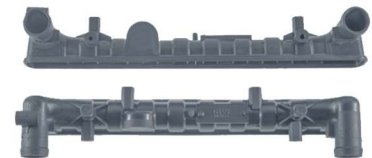

415mm x 42mm

765 / Gol G5 Superior Lado Mangueira Cebolão Aberto



415mm x 42mm

766 / Gol G5 Inferior Lado Retorno



415mm x 42mm

767 / Golf / Cross Fox Space Fox Inferior

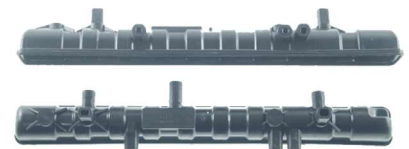

415mm x 42mm

768 / Gol G5 Similar Denso Inferior



416mm x 38mm

769 / Gol G5 Similar Denso Superior



416mm x 38mm

770 / Gol 87 Inferior



340mm x 45mm

780 / Gol 87 Superior



340mm x 45mm

790 / Gol Bola Canelado C/ Ar Superior Turbo



338mm x 55mm

791 / Gol Bola Canelado C/ Ar Inferior Turbo C/ Cano



338mm x 55mm

792 / Gol Bola Canelado C/ Ar Inferior Turbo S/ Cano

338mm x 55mm

800 / Gol Bola Canelado S/ Ar

340mm x 39mm

801 / Gol Bola Inferior S/ Ar Canelado C/ Cano

340mm x 39mm

802 / Gol Bola Inferior S/ Ar Canelado S/ Cano

340mm x 39mm

810 / Gol Bola Inferior C/ Ar C/ Cano

332mm x 60mm

820 / Gol Bola Inferior C/ Ar S/ Cano

332mm x 60mm

830 / Gol Bola Inferior C/ Cano

342mm x 38mm

840 / Gol Bola Inferior S/ Cano

342mm x 38mm

850 / Gol Bola Superior C/ Ar

332mm x 60mm

860 / Gol Bola Superior S/ Ar

342mm x 38mm

870 / Golf Mexicano

376mm x 46mm

871 / Golf Mexicano Inferior C/ Cebolão

376mm x 46mm

880 / Kombi Cebolão

415mm x 42mm

890 / Kombi Mangueira Ponta

415mm x 42mm

900 / Logus C/ Ar Lado Bico

378mm x 59mm

910 / Logus C/ Ar Lado Cebolão

378mm x 59mm

920 / Logus / Pointer / Escort Inferior S/ Ar Cebolão

322mm x 36mm

930 / Logus / Pointer / Escort Superior S/ Ar Bico

322mm x 36mm

940 / Passat

342mm x 47mm

950 / Polo Alemão Superior

377mm x 47mm

951 / Polo Alemão Inferior C/ Cebolão

377mm x 47mm

952 / Polo Alemão Inferior S/ Cebolão

377mm x 47mm

953 / Polo / Golf Antigo Superior Curto

322mm x 48mm

954 / Polo / Golf Antigo Inferior Curto

322mm x 48mm

960 / Santana Inferior

322mm x 48mm

970 / Santana Superior

322mm x 48mm

980 / Santana / Versailles 4 Saídas

322mm x 48mm

984 / UP Superior Similar Valeo

360mm x 42mm

985 / Santana / Versailles S/ Respiro

322mm x 48mm

986 / Up Inferior Similar Valeo

360mm x 42mm

987 / Up TSI Inferior Similar Behr

275mm x 42mm

988 / Up TSI Superior Similar Behr

275mm x 42mm

7588 / A3 / Jetta / Passat

455mm x 47mm

7596 / Audi A3 / Jetta Superior

455mm x 47mm

11746 / Amarok Lado Bico 2010>2014 2.0

593mm x 35mm

11747 / Amarok Sem Bico 2010>2014 2.0

593mm x 35mm

990 / Civic Comprido



677mm x 32mm

991 / Civic Comprido Maior



679mm x 32mm

992 / Civic Comprido Inferior C/ Elemento de Óleo



678mm x 39mm

993 / Civic Comprido Inferior S/ Elemento de Óleo



678mm x 39mm

994 / Civic 2013>2018 Superior



698mm x 32mm

1000 / Civic Largo C/ Ar



368mm x 47mm

1010 / Civic



370mm x 32mm

1011 / Civic Inferior C/ Ar e S/ Ar S/ Elemento de Óleo



371mm x 48mm

1012 / Civic Inferior C/ Ar e S/ Ar C/ Elemento de Óleo

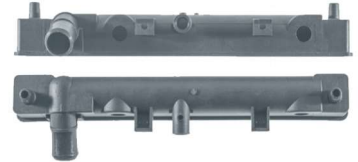

371mm x 48mm

1015 / New Civic Superior



698mm x 47mm

1016 / New Civic Inferior



698mm x 47mm

1170 / Fit Superior



400mm x 47mm

1171 / Fit Inferior Aberto



400mm x 47mm

1172 / Fit Inferior Fechado



400mm x 47mm

1175 / City / New Fit Superior



754mm x 34mm

1176 / City / New Fit Inferior



755mm x 40mm

1178 / Honda Fit /City superior 2014/2019



635 mm x 31 mm

1179 / Honda Fit/City inferior 2014/2019



638 mm x 38 mm

1180 / Accord Superior

697mm x 47mm

1181 / Accord Superior

707mm x 40mm

1182 / Accord Superior

697mm x 32mm

1183 / Accord Inferior C/ Elemento

706mm x 49mm

1184 / Accord Inferior S/ Elemento

706mm x 49mm

1187 / HRV Entrada da Água Superior

695mm x 31mm

1188 / HRV Saída da Água Inferior

695mm x 40mm

7712 / CRV 07/09 Superior

755mm x 48mm

QUALIDADE E EFICÁCIA

RADIADORES, SOLDAS E ACESSÓRIOS



SAIBA MAIS SOBRE NÓS

1090 / Sprinter Inferior

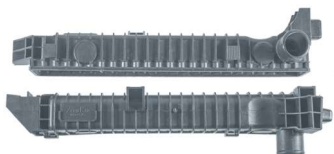

434mm x 60mm

1100 / Sprinter 310 Superior

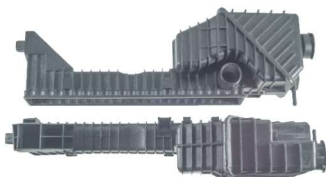

434mm x 60mm

1110 / Sprinter 313 / CDI

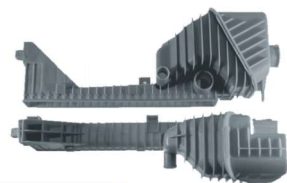

434mm x 60mm

1129 / Sprinter nova 2013>
Lado Retorno

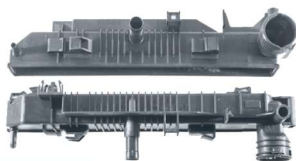

415mm x 50mm

1152 / Sprinter nova 2013>
Lado Sangrador

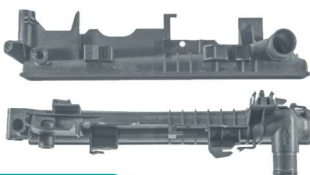

415mm x 50mm

40000 / Mercedes Classe A
Lado Dreno

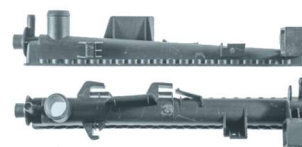

390mm x 42mm

40001 / Mercedes Classe A
Inferior



390mm x 42mm

CAIXAS LAND ROVER

7852 / Evoque Freelander LE



470mm x 42mm

1033 / Tucson/Sportage Superior C/ Elemento de Oleo

466mm x 46mm

1034 / Tucson/Sportage Inferior

466mm x 46mm

1038 / Tucson/Sportage Superior S/ Elemento de Oleo

466mm x 46mm

1111 / Hb20 Superior Manual

391mm x 34mm

1112 / Hb20 Inferior Manual

391mm x 34mm

1113 / Hb20 Superior Auto

392mm x 46mm

1114 / Hb20 Inferior Auto

392mm x 46mm

1115 / Ix35 Inferior Manual

492mm x 46mm

1117 / I30 / Cerato Superior Manual

458mm x 46mm

1118 / I30 / Cerato Superior Automatica

458mm x 46mm

1119 / I30 / Cerato Inferior

458mm x 46mm

1135 / Tucson Lisa Superior Fechado Manual

473mm x 46mm

1136 / Tucson Lisa Superior Aberto Automatico

473mm x 46mm

1137 / Tucson Lisa Inferior

473mm x 46mm

1138 / Ix35 Superior

492mm x 46mm

1139 / Ix35 Inferior Automatica

492mm x 46mm

1140 / H-100 Superior

592mm x 53mm

1147 / HR Inferior

590mm x 58mm

1160 / HR Superior



590mm x 58mm

7929 / Santa Fé 3.3/Kia Sorento Inferior Automático



491mm x 46mm

7935 / Azera / Sonata 06/11 AT LD



491mm x 47mm

7968 / Santa Fé 3.5 Superior



491mm x 46mm

7969 / Santa Fé 3.5 Inferior Automático



491mm x 46mm

7970 / Santa Fé 3.5 Inferior Manual



491mm x 46mm

7980 / Santa Fé 3.3/Kia Sorento Superior



491mm x 46mm

7992 / Santa Fé 3.5 / IX35 V6 10/16 Inferior Manual



490mm x 45mm

7991 / Picanto 06 / 11 Superior Automático



408mm x 44mm

8012 / Sportage 12> Santa Fé 3.5 Ix35 V6 10/16 Inf AT



490mm x 45mm

1144 / Pajero Superior



621mm x 55mm

1145 / Pajero Sport Superior



659mm x 54mm

1146 / Pajero Sport Inferior



659mm x 54mm

1150 / Pajero TR4 / Full Superior



678mm x 48mm

1151 / Pajero TR4 / Full Inferior



678mm x 48mm

1154 / L200 Superior Pino Perto



697mm x 50mm

1155 / L200 Superior Pino Longe



697mm x 50mm

1156 / L200 Inferior Pino Perto



697mm x 50mm

7440 / Outlander 2015> Gasolina
2.4 / 3.0 Superior



715mm x 35mm

7946 / Outlander/ASX/Lancer
09/14 2.0/2.4 Inferior



431mm x 44mm

7947 / Outlander / ASX / Lancer
09/14 superior



431mm x 46mm

7951 / L200 Triton/Dakar Diesel Auto
2008> Inferior Bocal Reto

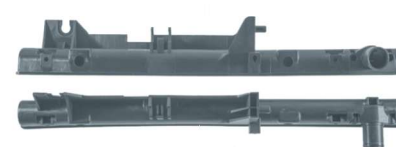

660mm x 47mm

7952 / L-200 Triton/ Pajero Dakar
Gasolina Aut 2008> Inf Bocal Torto



660mm x 47mm

7953 / L200 Triton / Dakar Diesel
Manual 2008> Inferior Bocal Reto

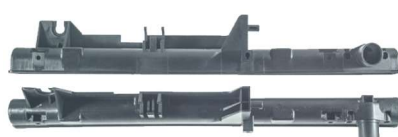

660mm x 47mm

7979 / L-200 Triton/ Pajero Dakar Gasolina
Manual 2008> Inf Bocal Torto

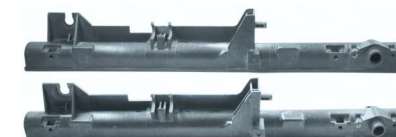

660mm x 47mm

7981 / L200 Triton / Dakar Gasolina / Diesel
Manual 08> Superior



660mm x 47mm

1059 / Livina Superior



612mm x 33mm

1141 / Frontier 2009> Inferior S/ Elemento de Óleo



714mm x 52mm

1142 / Frontier 2009> Inferior C/ Elemento de Óleo

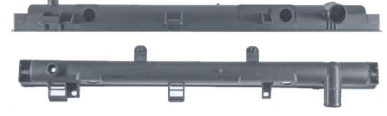

714mm x 52mm

1143 / Frontier 2009> Superior



712mm x 52mm

1148 / March / Versa Superior

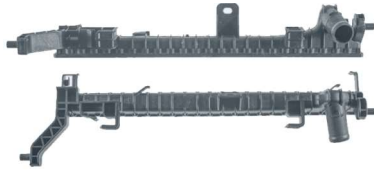

430mm x 31mm

1149 / March / Versa Inferior

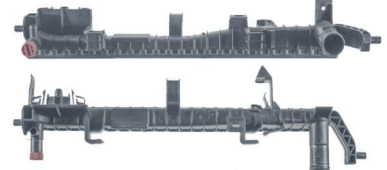

430mm x 31mm

1161 / Tiida Superior



612mm x 36mm

1162 / Tiida / Livina Inferior Manual

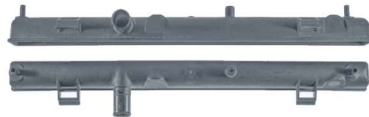

612mm x 50mm

1173 / Tiida / Livina Inferior AT



612mm x 50mm

1226 / Frontier Antiga C/ Retorno



698mm x 50mm

1227 / Frontier Antiga S/ Retorno



698mm x 50mm

7742 / Sentra 07/12 2.0/ 2.5 Superior



698mm x 33mm

<p>1040 / 206 Bico Fino</p> <p>564mm x 42mm</p>	<p>1050 / 206 Bico Largo</p> <p>564mm x 42mm</p>	<p>1051 / 206 Inferior C/ 1 Saída</p> <p>564mm x 42mm</p>
<p>1052 / 206 Inferior C/ 2 Saídas</p> <p>564mm x 42mm</p>	<p>1053 / 206 Inferior C/ 3 saídas</p> <p>564mm x 42mm</p>	<p>1054 / 408 Novo/3008 C4 Lounge</p> <p>563mm x 42mm</p>
<p>1055 / C4/Aircross Similar Denso Inferior 10/18</p> <p>561mm x 31mm</p>	<p>1056 / C4/Aircross Similar Denso Superior</p> <p>561mm x 31mm</p>	<p>1060 / 306 Citroen</p> <p>378mm x 42mm</p>
<p>1061 / 307 / C4 Superior C/ Retorno</p> <p>566mm x 47mm</p>	<p>1062 / 307 / C4 Inferior S/ Retorno</p> <p>566mm x 47mm</p>	<p>1082 / Reserv. 306 / 405 Gargalo Curto Engate Rápido</p> <p>379mm x 42mm</p>
<p>1083 / Reserv. 306 / 405 Gargalo Curto Engate Arame</p> <p>379mm x 42mm</p>	<p>1084 / Reserv. Partner / Berlingo Gargalo Engate Rápido</p> <p>379mm x 42mm</p>	<p>1085 / Reserv. Partner / Berlingo Gargalo Engate Arame</p> <p>379mm x 42mm</p>
<p>1086 / Reserv. 306 / 405 Gargalo Curto Bocal Liso P/ Abraçadeira</p> <p>379mm x 42mm</p>	<p>1087 / Reserv. Partner / Berlingo Gargalo Bocal Liso P/ Abraçadeira</p> <p>379mm x 42mm</p>	<p>1088 / 307/C4 Similar Denso Superior</p> <p>567mm x 42 mm</p>

CAIXAS PEUGEOT

1089 / 307/C4 Similar Valeo Superior



564mm x 42mm

1095 / 307/C4 Similar Denso Inferior



567 mm x 42 mm

1096 / 307/C4 Similar Valeo Inferior



564 mm x 42mm

CAIXAS JAC

7916 / Jac 2 1.4/16V Manual Superior



590mm x 32mm

7918 / J3 1.4/16V 2011> Superior RP



623mm x 37mm

11805 / V260 2.0 2022



588mm x 63mm

1063 / Duster
Mangueira na Ponta

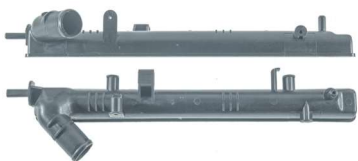

417mm x 42mm

1064 / Duster
Mangueira no Meio

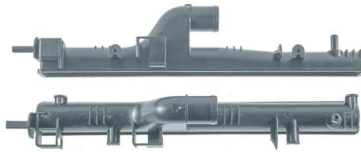

417mm x 42mm

1065 / Scénic Superior
Elemento Fechado



415mm x 42mm

1066 / Scénic Superior
Elemento Aberto

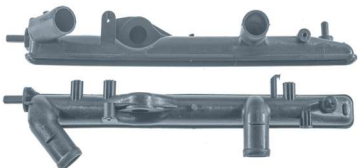

415mm x 42mm

1067 / Scénic Inferior



415mm x 42mm

1068 / Master Superior 2013>

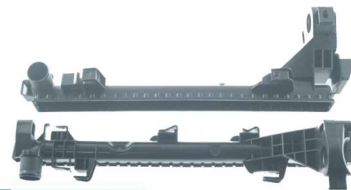

492mm x 40mm

1069 / Master Inferior 2013>
Lado Retorno

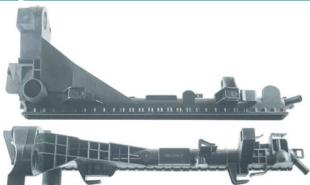

492mm x 40mm

1070 / Megane/Logan/Clio
Sandero Inferior S/ Tubete



415mm x 42mm

1071 / Megane/Logan/Clio
Sandero Inferior C/ Tubete



415mm x 42mm

1072 / Clio Agulha Inferior
S/ Tubete



378mm x 42mm

1073 / Duster/Sandero/Logan
Mangueira na Ponta



410mm x 30mm

1074 / Duster/Sandero/Logan
Mangueira no Meio

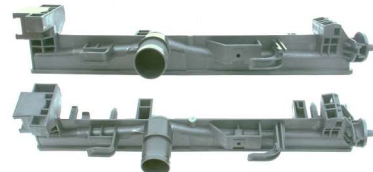

410mm x 30mm

1075 / Sandero C/ Bico



401mm x 34mm

1076 / Sandero S/ Bico



410mm x 34mm

1077 / Kwid 1.0 12V Inferior
2017/2020



365mm x 34mm

1078 / Kwid 1.0 12V Superior
2017/2020



365mm x 34mm

1079 / Logan/Sandero 1.0
2014 Lado Bico



417 mm x 28 mm

1080 / Megane Superior

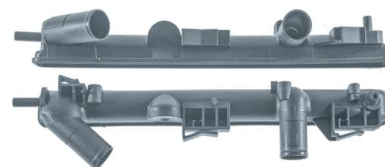

415mm x 42mm

1081 / Clio 1.6 Argentino

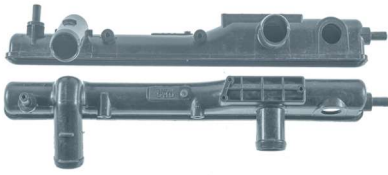

415mm x 42mm

1195 / Clio Agulha Superior

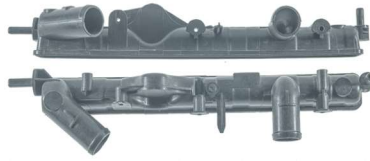

380mm x 42mm

1196 / Clio Agulha Inferior

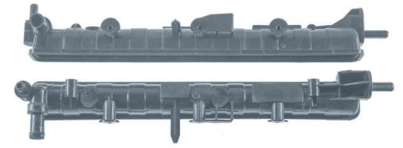

380mm x 42mm

1097 / Logan/Sanderó 1.0
2014



417 mm x 28 mm

7800 / Vitara Superior
Mangueira LD



544mm x 47mm

7801 / Vitara / Tracker
Inferior C/ Elemento



544mm x 47mm

7802 / Vitara / Tracker Superior
Mangueira LE



544mm x 47mm

7955 / Vitara Inferior
S/ Elemento



544mm x 47mm

1120 / Corolla Largo Tampa



715mm x 45mm

1121 / Corolla Fino Tampa



657mm x 31mm

1122 / Corolla Lado Sangrador
2003 em Diante



370mm x 32mm

1123 / Corolla Lado Tampa
2003 em Diante



372mm x 39mm

1124 / Corolla Fina Superior
C/ Elemento de Óleo 2009>



400mm x 40mm

1125 / Corolla Fina Inferior
2009>



400mm x 33mm

1126 / Corolla Fina Superior
S/ Elemento de Óleo 2009>



400mm x 40mm

1127 / Etios Superior



565mm x 33mm

1128 / Etios Inferior



565mm x 33mm

1190 / Hilux 3.0 Superior
C/ Retorno



679mm x 48mm

1191 / Hilux 3.0 Inferior
2 Saídas S/ Elemento



679mm x 48mm

1192 / Camry Superior
4 Fixações Tampa



740mm x 33mm

1193 / Hilux Superior Tampa
Mangueira Ponta



679mm x 48mm

1194 / Hilux Inferior
Mangueira Ponta



679mm x 48mm

1197 / Hilux Inferior Sangrador
C/ Elemento Aberto



679mm x 48mm

1198 / Hilux SW4 Superior
Tampa



660mm x 47mm

1199 / Hilux SW4 Superior
Tampa



660mm x 54mm

1201 / Hilux SW4 Inferior
C/ Elemento Fechado



660mm x 47mm

1202 / Hilux SW4 Inferior
C/ Elemento Aberto



660mm x 47mm

1203 / Hilux SW4 Inferior
C/ Elemento Fechado



660mm x 57mm

1204 / Hilux SW4 Inferior
C/ Elemento Aberto



660mm x 57mm

1207 / Hilux Turbo Curta
Inferior



545mm x 55mm

1208 / Hilux Curta Superior
C/ Retorno



545mm x 55mm

1209 / Hilux Aspirada Curta
Inferior



545mm x 55mm

1223 / Hilux Lado Retorno 2016>



675mm x 43mm

1224 / Hilux SW4 Superior
Gasolina Mangueira LD



660mm x 47mm

1225 / Hilux SW4 Superior
Gasolina Mangueira LD



660mm x 57mm

1242 / Hilux Inferior 2016>



675mm x 43mm

1301 / Hilux Sw4 Inferior
Bocal Lado Direito



660mm x 47mm

1302 / Hilux Sw4 Inferior
Bocal Lado Direito



660mm x 57mm

7738 / Toyota Empilhadeira Inferior
Bocal Fino



446mm x 58mm

8301 / Toyota Empilhadeira Inferior
Bocal Lado Esquerdo



465mm x 68mm

8302 / Toyota Empilhadeira Inferior
Bocal Lado Direito



465mm x 68mm

9095 / Toyota Empilhadeira G Inferior
Bocal Lado Direito



446mm x 85mm

1028 / Nova C-3 Superior



415mm x 42mm

1029 / Nova C-3 Inferior



415mm x 42mm

1031 / C3 Superior



415mm x 42mm

1032 / C3 Inferior



415mm x 42mm

1035 / C3 S/ Cano



415mm x 42mm

1042 / DS3/DS4/Aircross/Peugeot Engate Rápido C/Retorno



560mm x 41mm

1043 / DS3/DS4/Aircross/Peugeot Engate Rápido S/Retorno



560mm x 41mm

1044 / DS3/DS4/Aircross/Peugeot Superior Rebaixada



560mm x 41mm

1045 / DS3/DS4/Aircross/Peugeot Inferior 2 Encaixes



560mm x 41mm

1046 / DS3/DS4/Aircross/Peugeot 208 Superior



563mm x 43mm

1047 / DS3/DS4/Aircross/Peugeot 208 Inferior 3 Encaixes



563mm x 43mm

1055 / Citroen/ Aircross Similar Denso Inferior 10/18



561mm x 31mm

1056 / Citroen/ Aircross Similar Denso Superior 10/18



561mm x 31mm