



CAIXAS

LINHA PESADA

LINHA PESADA
LINHA PESADA
LINHA PESADA

CENTRAL DE VENDAS

(11) 95456-6290
(11) 94538-8656
(11) 95796-0176
(11) 95804-9330
(11) 97895-9270
(11) 95968-7415
(11) 95824-7581

vendas@supersoldas.com.br (Alessandra)
andrea@supersoldas.com.br
carla@supersoldas.com.br
evelyn@supersoldas.com.br
fabiana@supersoldas.com.br
fernanda@supersoldas.com.br
ketlyn@supersoldas.com.br

1205 / Axor Superior Similar Behr



701mm x 77mm

1206 / Axor Inferior Similar Behr



701mm x 77mm

1217 / 1620 Eletrônico Superior C/ Bico Reto



647mm x 76mm

1218 / 1620 Eletrônico Superior C/ Bico em Grau



647mm x 76mm

1219 / 1620 Eletrônico Inferior S/ Retorno



647mm x 76mm

1221 / 1620 Eletrônico Inferior C/ Bocal Inclinado



647mm x 76mm

1222 / Axor Inferior Similar Behr Fechada



701mm x 77mm

1317 / 1620 Eletrônico Superior C/ Mang. e Bico Reto



647mm x 76mm

1318 / 1620 Eletrônico Superior C/ Mang. e Bico em Grau



647mm x 76mm

11641 / New Actros / Arocs Inferior 20 / 24



1080mm x 73mm

11642 / New Actros / Arocs Superior 20 / 24



1080mm x 73mm

11698 / Accelo C/ Retorno Similar Visconde



495mm x 76mm

11699 / Accelo S/ Retorno Similar Visconde



495mm x 76mm

11703 / 0500 Bico LE Mangueira LD

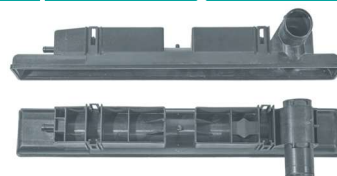

655mm x 92mm

11704 / 0500 Bico Reto P/ Cima



655mm x 92mm

11705 / 0500 C/ Cebolão Aberto

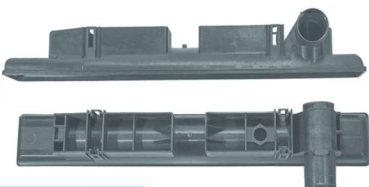

656mm x 92mm

11706 / 0500 Bico LD Mangueira LE

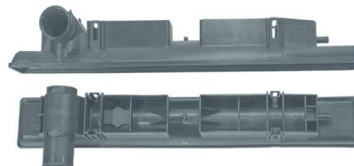

656mm x 92mm

11709 / Accelo C/ Retorno



497mm x 77mm

11710 / Accelo S/ Retorno



497mm x 77mm

11713 / Axor Inferior Similar Valeo



690mm x 80mm

11714 / Atego Superior Similar Behr Bico

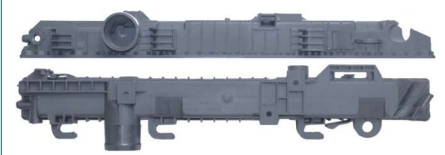

582mm x 60mm

11715 / Atego Inferior Similar Behr Mangueira do Lado



582mm x 60mm

11719 / Atego Inferior Similar Behr Mangueira Ponta



582mm x 60mm

11724 / 0500 Mangueira LE S/ Respiro



655mm x 92mm

11725 / Axor Superior C/ Retorno Similar Valeo



690mm x 80mm

11738 / Ategão Similar Valeo Inferior Bocal Duplo



776mm x 75mm

11739 / Ategão Similar Valeo Superior



776mm x 75mm

11741 / Actros Superior



840mm x 77mm

11742 / Actros Inferior



840mm x 77mm

11758 / 1634 C/ Sangrador



715mm x 70mm

11759 / 1634 C/ Retorno



715mm x 70mm

RADIADORES E ACESSÓRIOS
LINHA PESADA
QUALIDADE E EFICÁCIA



RADIADORES,
SOLDAS E
ACESSÓRIOS

1157 / Constellation
Inferior Mangueira LD



680mm x 85mm

1163 / Constellation
Superior Mangueira LE



680mm x 85mm

1164 / Constellation
Inferior Mangueira LE



680mm x 85mm

1228 / Constellation
Superior Mangueira LD



683mm x 85mm

1247 / Constellation
13180/15180/15190



453mm x 84mm

1248 / Constellation 13180/15180
15190 C/ Retorno



453mm x 84mm

1263 / Constellation Superior
Com Bico



608mm x 59mm

1264 / Constellation Superior
Com Tres Bico



608mm x 59mm

1265 / Constellation Inferior
Sem Bico



608mm x 59mm

7783 / Constellation 2008
Superior Esquerdo



688mm x 85mm

7784 / Constellation 2008
Mangueira LD Superior



688mm x 85mm

7785 / Constellation 2008
Inferior



688mm x 85mm

11616 / 8-160 Bocal Lado
Esquerdo Superior



615mm x 85mm

11617 / 8-160 Bocal Lado
Esquerdo Inferior



615mm x 85mm

11618 / 8-160 Bocal Lado Esq.
C/ Retorno Superior



615mm x 85mm

11666 / 8-160 Bocal Lado Esq.
Bico Lado Dir.



615mm x 85mm

11700 / Constellation
MAN Mangueira LD



681mm x 85mm

11707 / Constellation
MAN Inferior

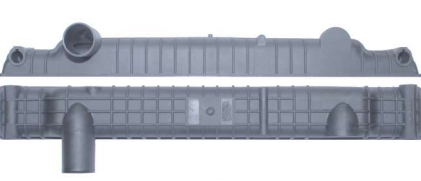

681mm x 85mm

11708 / Constellation MAN Superior

681mm x 85mm

11716 / 8-160 Superior

614mm x 85mm

11717 / 8-160 Inferior

614mm x 85mm

11718 / 8-160 Superior C/ Retorno

614mm x 85mm

11722 / 8-160 Inferior Retorno Invertido 25mm

614mm x 85mm

11728 / 8-160 Superior Bico Lado Esquerdo

615mm x 85mm

11745 / 8-160 Mangueira LD 3 Bicos

612mm x 85mm

11748 / Constellation Man Mangueira LE

681mm x 85mm

11749 / Constellation Man Inferior Mangueira LD

681mm x 85mm

11760 / Delivery C/ Retorno 2018>

630mm x 50mm

11761 / Delivery S/ Retorno 2018>

630mm x 50mm

11766 / 8-160 Mangueira Bico LD

612mm x 85mm

11768 / 8-160 Inferior Retorno Invertido 16.35mm

614mm x 85mm



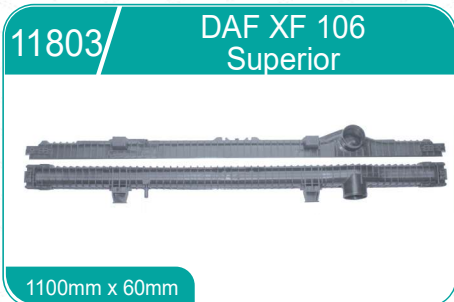
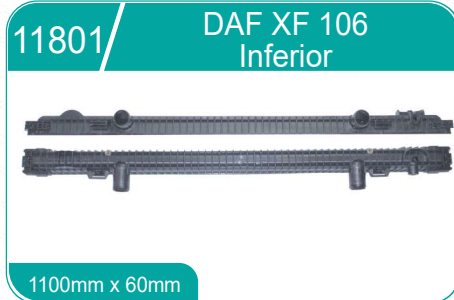
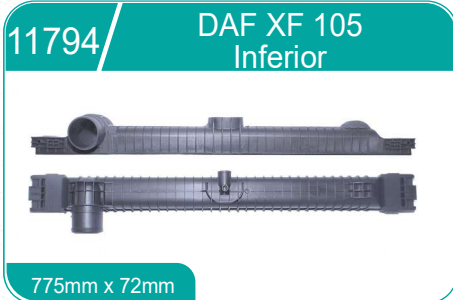
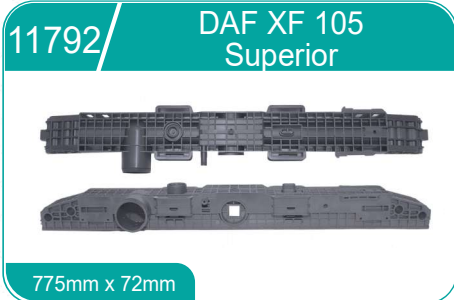

RADIADORES E ACESSÓRIOS
LINHA PESADA
QUALIDADE E EFICÁCIA

RADIADORES,
SOLDAS E
ACESSÓRIOS

1158 / FM Superior Antigo



752mm x 80mm

1159 / FM Superior Novo



748mm x 76mm

1165 / FH Superior



910mm x 80mm

1174 / FH Superior Nova

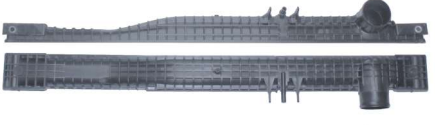

911mm x 70mm

1177 / FH Inferior Nova



911mm x 70mm

1185 / VM 2011> Inferior



592mm x 71mm

1186 / VM 2011> Superior



592mm x 71mm

1229 / VM Superior

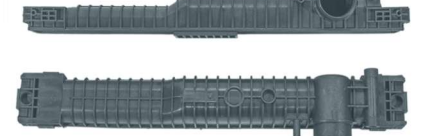

595mm x 71mm

1231 / VM Inferior



595mm x 71mm

1232 / FH Inferior



910mm x 80mm

1237 / FM Inferior Novo



748mm x 76mm

1724 / FMX Superior

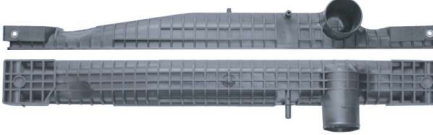

749mm x 70mm

1725 / FMX Inferior



749mm x 70mm

11723 / FM Inferior Antigo



752mm x 80mm

11637 / Retroescavadeira Case S/ Tampa
580L / Ser. 2 580M/590 Inserto Invertido

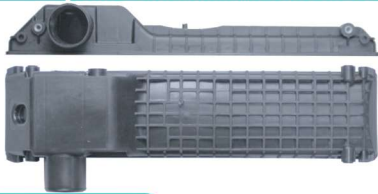

528mm x 125mm

11638 / Caterpillar 416-F2 Bocal 58mm
Inferior



528mm x 125mm

11639 / Caterpillar 416-F2 Bocal 58mm
Superior C/ Retorno



528mm x 125mm



11729 / Caterpillar / Valtra / BH 180 / Massey
New Holland Retorno - 11mm

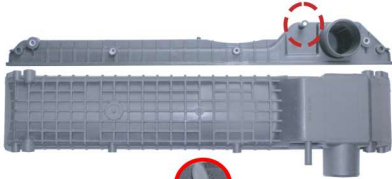

641mm x 125mm



11730 / Caterpillar / Valtra / BH 180 / Massey
New Holland Retorno - 20mm



641mm x 125mm



11735 / Caterpillar / Valtra / BH 180 / Massey
New Holland Bocal Invertido

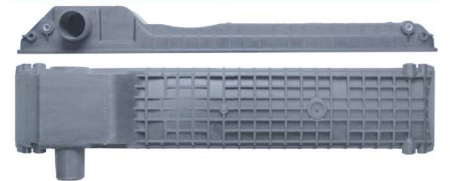

641mm x 125mm

11736 / Retroescavadeira Case C/ Tampa
580L / Ser. 2 580M / 590



528mm x 125mm

11737 / Retroescavadeira Case S/ Tampa
580L / Ser. 2 580M / 590



528mm x 125mm

11743 / Case Mx 35 New Holland Lb90
C/ Tampa



570mm x 125mm

11744 / Case Mx 35 New Holland Lb90
S/ Tampa



570mm x 125mm

11750 / Trator Case Mx 180



545mm x 144mm

11751 / Trator Case Mx 180 C/ Tampa



545mm x 144mm

11752 / Trator Case Mx 180 S/ Tampa



544mm x 144mm

11753 / Caterpillar / Valtra / BH 180 / Massey
New Holland Bocal S/ Retorno

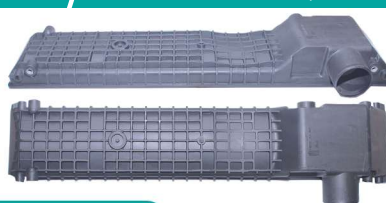

641mm x 125mm

11754 / Caterpillar / Valtra / BH 180 / Massey
New Holland Bocal Invertido

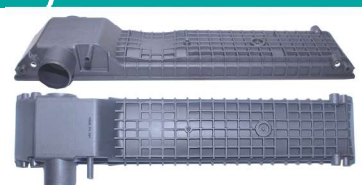

641mm x 125mm

11755 / Trator John Deere 2001>2011
Inferior



545mm x 110mm

11756 / Trator New Holland T1
70 / 75 80 / 100 Superior



544mm x 105mm

11757 / Trator John Deere 2001>2011
Superior C/ Tampa e Retorno



545mm x 110mm

11762 / Case Mx 35 New Holland Lb 90 C/ Tampa e Bocal Invertido



575mm x 125mm

11763 / Case Mx 35 New Holland Lb 90 S/ Tampa e Bocal Invertido



575mm x 125mm

11764 / Caterpillar / Valtra / BH 180 / Massey New Holland Bocal Fino



641mm x 125mm

11765 / Trator New Holland TI 70 / 75 / 80 / 100 Inferior



545mm x 110mm

11767 / Case MX 35 New Holland LB 90 Bocal Mangueira LE - 16mm



574mm x 125mm

11769 / Case Mx35 New Holland LB 90 Bocal Mangueira LE - 21mm



574mm x 125mm

11780 / Caterpillar / Valtra / BH 180 / Massey New Holland Bocal Grosso S/ Retorno



730mm x 125mm

11781 / Caterpillar / Valtra / BH 180 / Massey New Holland Bocal Fino C/ Retorno Grosso



730mm x 125mm

11782 / Caterpillar / Valtra / BH 180 / Massey New Holland C/ Tampa Bocal Fino



730mm x 125mm

11783 / Caterpillar / Valtra / BH 180 / Massey New Holland Bocal Grosso C/ Retorno Fino



730mm x 125mm

11784 / Caterpillar / Valtra / BH 180 / Massey New Holland Bocal Fino S/ Tampa

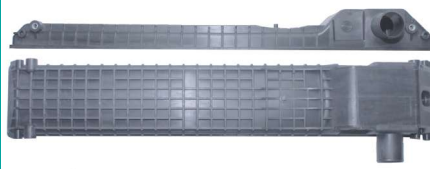

730mm x 125mm

11785 / Caterpillar / Valtra / BH 180 / Massey New Holland Bocal Grosso LE



730mm x 125mm

11786 / Caterpillar / Valtra / BH 180 / Massey / New Holland Bocal Grosso LE C/ Porca



730mm x 125mm

11787 / Caterpillar / Valtra / BH 180 / Massey C/ Retorno



730mm x 125mm

11788 / Massey Ferguson Mangueira Fina



508mm x 110mm

11789 / Massey Ferguson Mangueira Grossa



508mm x 110mm

11790 / Case Mx35 New Holland Lb90 Sensor Lado Bocal



570mm x 125mm

11791 / Massey Ferguson Inferior Mangueira Fina



513mm x 110mm

11793 / Case Mx35 New Holland
Lb90 S/ Tampa Rosca 3/8 BSP



572mm x 125mm

11796 / John Deere 6000

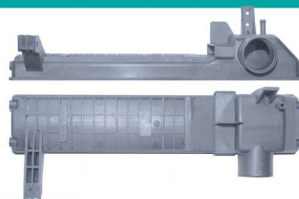

510mm x 109mm

11811 / Caterpillar / Valtra / BH 180 / Massey
New Holland Retorno - 26mm



641mm x 125mm

11812 / Case Mx35 New Holland
Lb90 S/ Tampa Rosca 1/4 BSP



572mm x 125mm

11813 / Case Mx35 New Holland
Lb90 S/ Sensor



572mm x 125mm

11814 / Massey Ferguson
Mangueira Reta



510mm x 110mm

11815 / Hyster F50 / H55 / 55XM
Superior



465mm x 114mm

11816 / Hyster F50 / H55 / 55XM
Inferior Sem Dreno



465mm x 114mm

11817 / Hyster F50 / H55 / 55XM
Inferior Com Dreno



465mm x 114mm

11818 / Case Puma T7070 / T7060
New Holland T7000 Inferior



642mm x 147mm

11819 / Case Puma T7070 / T7060
New Holland T7000 Superior



642mm x 147mm

11820 / Hyster Moderna Superior
Mangueira Lado Direito



463mm x 113mm

11821 / Hyster Moderna Inferior
Com Dreno



463mm x 113mm

CAIXAS PLASTICAS
DE TRATORES
E EMPILHADORES



1166 / P94 C/ Retorno



718mm x 71mm

1167 / P94 S/ Retorno



718mm x 71mm

1168 / 124 Série 4 C/ Retorno



964mm x 72mm

1169 / 124 Série 4 S/ Retorno



964mm x 72mm

1235 / 124 Série 5 C/ Retorno P

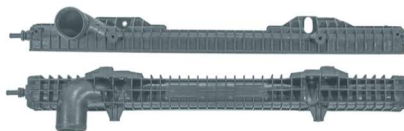

712mm x 59mm

1236 / 124 Série 5 S/ Retorno P



712mm x 59mm

11701 / 124 Série 5 C/ Retorno M



953mm x 59mm

11702 / 124 Série 5 S/ Retorno M

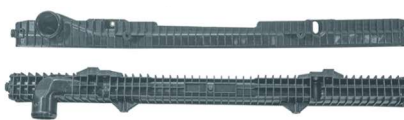

953mm x 59mm

11720 / Série 6 Superior Mangueira na Ponta G



1075mm x 59mm

11721 / Série 6 Inferior Mangueira no Meio G



1075mm x 59mm

11726 / 124 Série 5 C/ Retorno G



1025mm x 59mm

11727 / 124 Série 5 S/ Retorno G

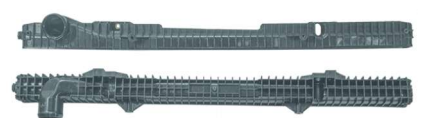

1025mm x 59mm

11731 / Série 6 Superior Mangueira na Ponta P



955mm x 59mm

11732 / Série 6 Inferior Mangueira no Meio P



955mm x 59mm

11733 / Série 6 Superior Mangueira na Ponta M



1005mm x 60mm

11734 / Série 6 Inferior Mangueira no Meio M



1005mm x 60mm

11797 / Série 7 M Inferior



850mm x 60mm

11798 / Série 7 Superior P



750mm x 60mm

CAIXAS PESADA SCANIA

11799 / Série 7 Inferior P



750mm x 60mm

11800 / Série 7 M Superior



850mm x 60mm

11808 / Série 7- G Superior
Mangueira Meio



1030mm x 60mm

11809 / Série 7- G Inferior
Engate Rápido



1030mm x 60mm

CAIXAS PESADA IVECO

1018 / Daily Nova Superior
C/ Bico 08/12



458mm x 54mm

1019 / Daily Nova Inferior
08/12

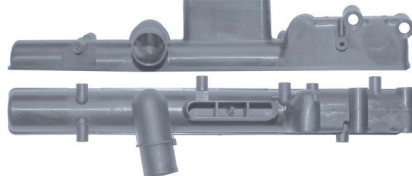

458mm x 54mm

1020 / Daily Inferior
Similar Behr 98/07



448mm x 63mm

1021 / Daily Inferior
Similar Visconde 98/07

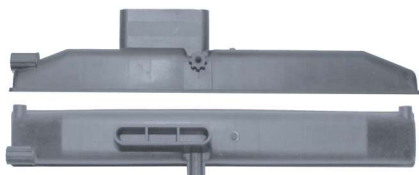

450mm x 63mm

1022 / Daily Superior
Similar Visconde 98/07



450mm x 63mm

1030 / Daily Superior
Similar Behr 98/07



448mm x 63mm

1215 / Cavalino C/ Retorno



646mm x 77mm

1216 / Cavalino S/ Retorno



646mm x 77mm

1233 / Eurocargo / Tector
C/ Retorno Valeo



600mm x 59mm

1234 / Eurocargo / Tector S/ Retorno Valeo



600mm x 59mm

1238 / Strallis LD Retorno

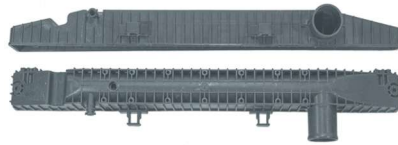

775mm x 73mm

1239 / Strallis LD Sangrador



775mm x 73mm

1243 / Eurocargo / Tector Similar Behr C/ Retorno



581mm x 60mm

1244 / Eurocargo / Tector Similar Behr C/ Sangrador



581mm x 60mm

1245 / Vertis 90V16 Bocal Reto 130V18 10/12



455mm x 84mm

1246 / Vertis 90V16 Bocal Grau S/ Retorno 130V18 10/12



455mm x 84mm

1251 / Strallis LD Retorno Bocal Engate Rápido



775mm x 74mm

1252 / Strallis LD Sangrador Bocal Engate Rápido

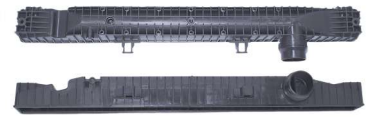

775mm x 74mm

7164 / 35 S13 City / Ducato Moderna Superior Peq.



462mm x 52mm

7168 / 35 S13 City / Ducato Moderna Inferior Peq.

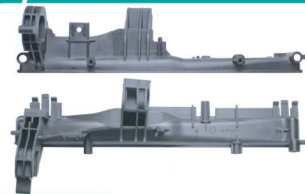

462mm x 52mm

7430 / Daily 5C16 MotorEuroV 13/19 LD Motorista

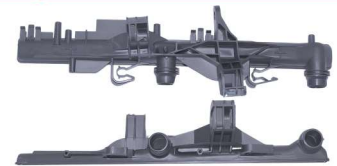

627mm x 52mm

7431 / Daily 5C16 MotorEuroV 13/19 LD Carona

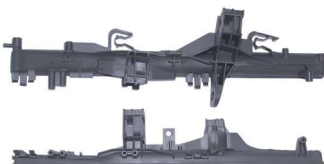

627mm x 52mm

CAIXAS PESADA FORD

1211 / Cargo Eletrônico Superior

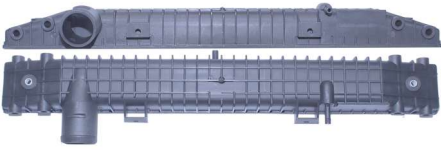

644mm x 76mm

1212 / Cargo Eletrônico Inferior

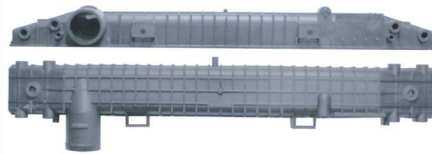

644mm x 76mm

1213 / Cargo Eletrônico Superior (P) C/ Porca



575mm x 77mm

1214 / Cargo Eletrônico Inferior (P) S/ Porca

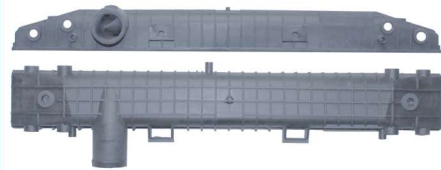

575mm x 77mm

CAIXAS PESADA KIA

1130 / Grand Besta Superior



555mm x 53mm

1131 / Besta GS Inferior



556mm x 45mm

1132 / Besta GS Superior



556mm x 45mm

1133 / Bongo 2.5 Diesel 13/19 Inferior



589mm x 61mm

7250 / Bongo Nova Superior



588mm x 62mm

11711 / Bongo Superior



557mm x 69mm

11712 / Bongo Inferior

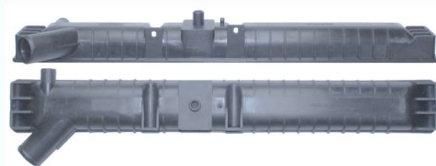

557mm x 69mm

7251 / Bongo Nova Inferior



588mm x 62mm

7897 / Man TGX Reservatorio



964mm x 73mm

7902 / Man TGX inferior



964mm x 73mm

8105 / Daf CF 65 Superior



645mm x 78mm

**8108 / Daf Moderna Superior
C/ Bico Mang. Inclinada**



1104mm x 60mm

8238 / Daf CF 65/85 Inferior



645mm x 78mm