



ACESSÓRIOS DIVERSOS

CENTRAL DE VENDAS

Alessandra	(11) 95456-6290	vendas@supersoldas.com.br
Carla	(11) 95796-0176	carla@supersoldas.com.br
Evelyn	(11) 95804-9330	evelyn@supersoldas.com.br
Fabiana	(11) 97895-9270	fabiana@supersoldas.com.br
Jamile	(11) 97895-8886	jamile@supersoldas.com.br
Ketlyn	(11) 95824-7581	ketlyn@supersoldas.com.br

90000/

Cobalt / Onix

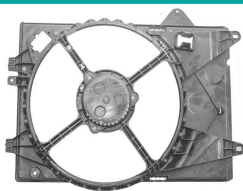

90003/

Uno Vivace/ Palio
Siena S/ Ar Similar Denso



90004/

Gol G5 S/ Ar



90005/

Palio Fire C/S Ar / Idea
C/ Ar Similar Valeo

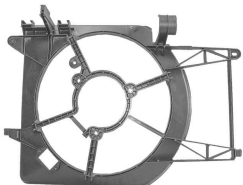

90006/

Palio Fire C/ Ar / Idea C/ Ar
Suporte G Similar Behr

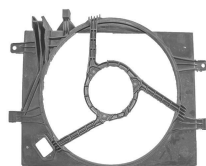

90007/

Palio Fire S/ Ar
Suporte G Similar Behr



90008/

Celta Antigo C/ Ar

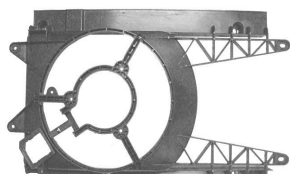

90010/

Palio 1.0

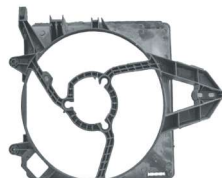

90011/

Corsa / Montana C/ Ar

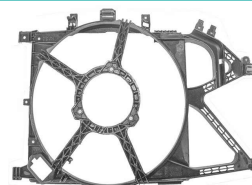

90012/

Condensador HRV 2016>
New Civic 2012/2015



90016/

Palio / Idea Fire C/S Ar
Similar Bosch



90020/

Palio 1.5 S/ Ar

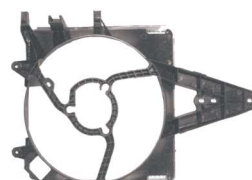

90021/

Celta S/ Ar Similar Valeo

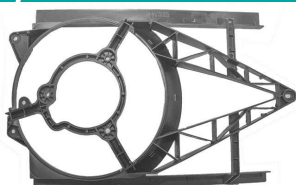

90022/

New Civic 1.8 06/11

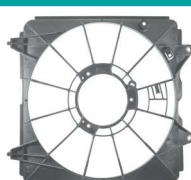

90030/

Palio 1.5 C/ Ar

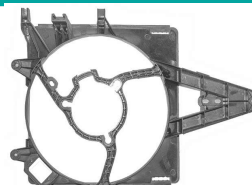

90031/

Vectra C/ Ar

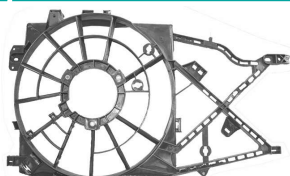

90032/

Corsa S/ Ar

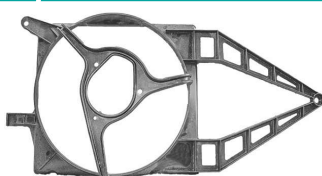

90033/

Corsa Classic



90034/ Celta / Prisma

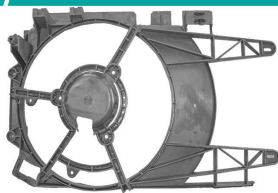

90035/ Fiesta S/ Ar

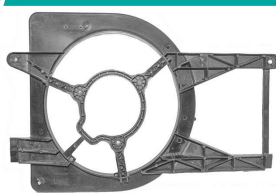

90036/ Astra

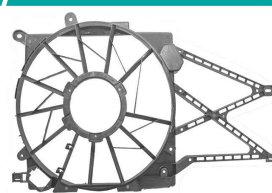

90037/ Gol G5 C/ Ar

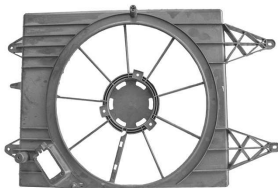

90038/ Uno C/ Vaso Médio Similar Denso

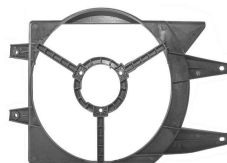

90048/ Uno Fire Similar Valeo

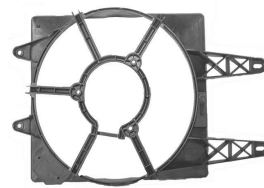

90049/ Fiesta / Ecosport Similar Valeo

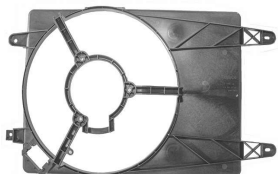

90053/ Uno Vivace / Palio / Siena Similar Denso

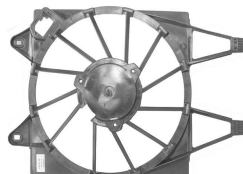

90057/ Uno Fire C/ Ar Similar Valeo 03/13

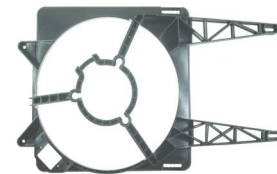

90088/ Vectra / Astra 2010



90089/ Corsa/Montana C/ Ar 2008



90092/ Gol / Parati / Saveiro C/ Ar G2 / G3 / G4

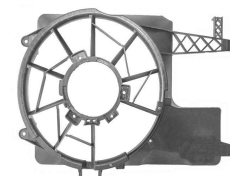

90093/ Gol / Parati / Saveiro S/ Ar G2 / G3 / G4

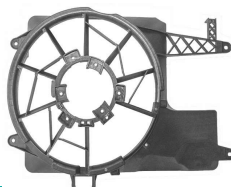

90094/ New Civic 12/16



90095/ Condensador Corsa Classic



90096/ Sandero / Logan / Megane / Kangoo / Symbol



90723/ Fit (Água)



90725/ Condensador New City / New Fit



90751/

HRV 2016



90753/

Kwid 1.0 2017

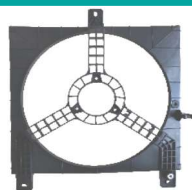

90755/

206/207 C/Ar 01/04



90922/

Palio Fire Similar Behr
C/ Ar Suporte P

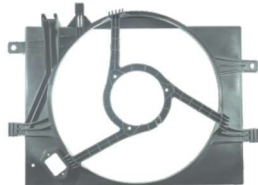

90923/

Palio Fire Similar Behr
S/ Ar Suporte P

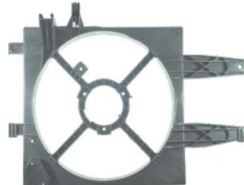

90940/

Agile / Montana
10> C/ Ar

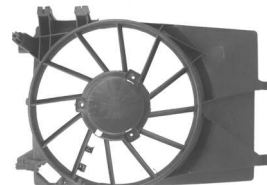

90941/

Corsa Classic C/ Ar
01/10 Motor G



90943/

Argo / Cronos 1.0
17/21 C/ Ar



90945/

Strada 1.3 / Uno 2017>

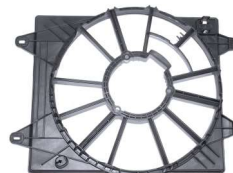

90946/

Strada 1.4 2017>



90972/

Polo / Fox C/ Ar
03/07 Duplo

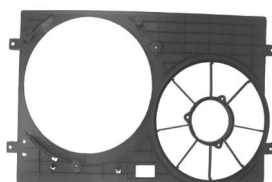

90982/

HB 20 / Veloster 00>



90991/

Corolla 2.0 09/18 C/ Ar



99720/

Corsa Classic C/ Ar
01/10 Motor P



99721/

Condensador Fit
Antigo

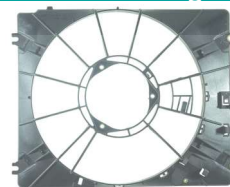

99722/

Corsa / Montana
S/ Ar

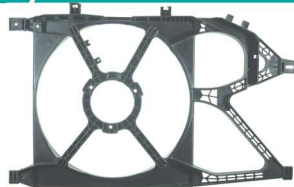

99723/

Suporte Frontal Superior
Defletor/Radiador Corolla 1.8



99731/

City / New Fit 08/14
Água

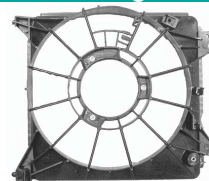

99732 / Corolla 1.8 09/18 C/ Ar



99733 / Condensador CRV 12/17



99734 / CRV 12/17



99902 / UP MPI

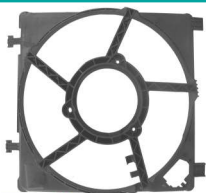

99904 / Uno Vivace C/ Ar Similar Valeo



99941 / Cobalt/Onix/Novo Prisma 2017 Automático

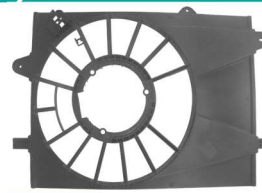

99942 / Cobalt/Onix/Novo Prisma 2017 Manual

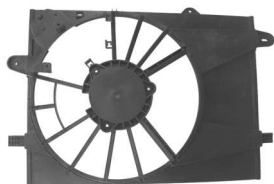

99943 / Logan / Sandero 1.0 8v 14/16

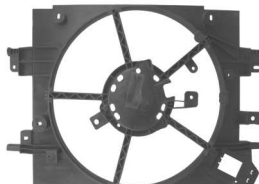

90001 / Doblo 1.3/1.8 02/09
C/ Ar Similar Denso

90002 / Doblo 1.4 10/20
C/ Ar Similar Denso

90013 / Fiesta Sreet 00/04

90014 / Ka Endura 97/00 S/ Ar

90015 / Focus 2.0 16V 09/14

90018 / Meriva 1.4/1.8 02/05
C/ Ar

90039 / Fox / Crossfox / Polo 06/12
C/ Ar

90050 / Condensador Astra
Zafira / Vectra 99/09 C/ Ar

90051 / Condensador Vectra 97/05 C/ Ar

90078 / Ducato C/ Ar 00>

90087 / Escort Zetec

90099 / Condensador Corsa 1.0/1.8

90103 / Picasso Frontal C/ Ar

90104 / Picasso Funil C/ Ar

90133 / 206 S/ Ar

90135 / Sprinter 97-02

90136 / Sprinter CDI 02/12

90137 / Jetta/ A3/ Tiguan Turbo

90138 / Sprinter 310/312 97/02

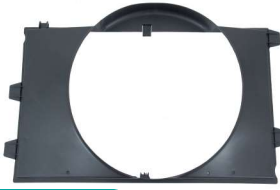

90139 / Audi A4/A5/Q5
2009> Duplo

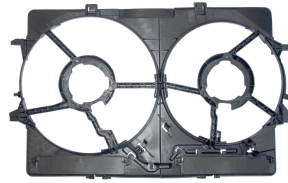

90140 / Picanto Sem
Reservatório 04/09



90519 / Berlingo
Partner 1998>



90750 / Novo Ecosport / Ka Novo
New Fiesta

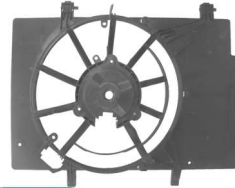

90756 / Hilux 2016>



90877 / I30 2013 / Cerato 2013

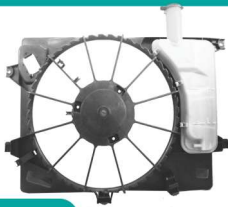

90878 / 307 / C4 Pallas 2002

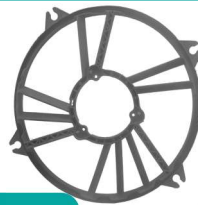

90883 / Blazer Trail 3.6 2013

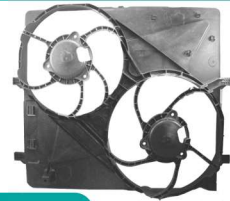

90884 / Jetta / Audi A3 / Tiguan
Passat 2.0T 2007

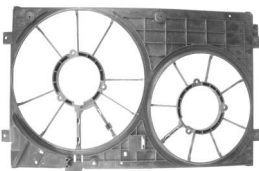

90886 / Scenic 99 C/ Ar

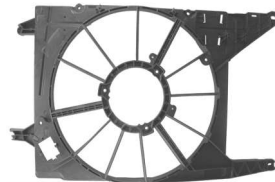

90887 / C3 Moderno 2001
Manual C/ Ar



90888 / Clio 2000 C/ Ar

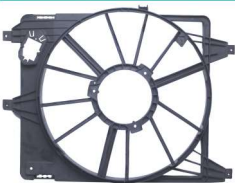

90892 / Santa Fé 2006 / 2009
C/ Ar Lado Motorista

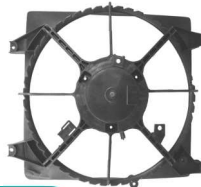

90893 / Santa Fé 2006 / 2009
C/ Ar Lado Carona



90896 / Tucson 2.0 2005 Suporte
Baixo 06 C/ Ar

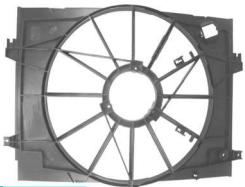

90897 / Santa Fé 2010> C/Ar

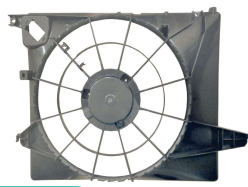

90898 / 206 / 207 C/ Ar
Frontal 2000

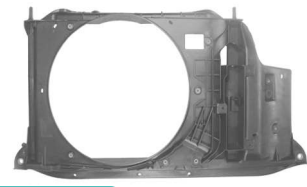

90901 / L200 Triton



90902 / Hilux Flex 05 / 06



90903 / Hilux Diesel 05 / 16



90906 / Etios 13



90907 / Doblo S/ Ar

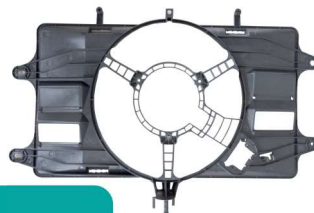

90909 / Virtus 19 / Polo 18 1.0 Turbo

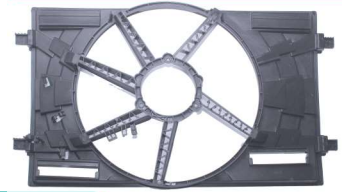

90952 / C3 03 Frontal Manual



90953 / Azera 2008 / 2011 S/ Resistência



90960 / Accord 2.4 Lado Carona 2008

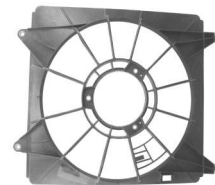

90961 / Cherokee Sport C/ Ar

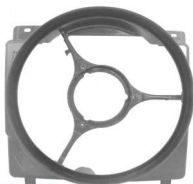

90962 / Civic Lado Carona C/ Ar

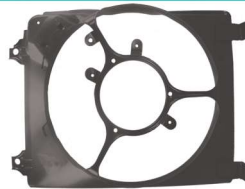

90963 / I30 10 C/ Ar



90964 / Mégane Grand Tour 06

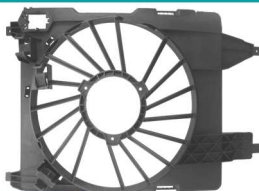

90965 / Picanto 2012> C/Reservatório



90966 / Picanto 2009 C/Reservatório



90967 / S10 2.4 2013> 1 motor

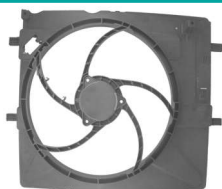

90970 / Tiida 2008 C/ Ar Todos

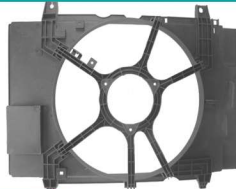

90971 / Soul 08

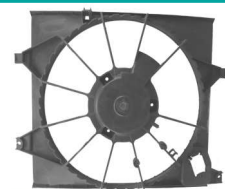

90973 / New Sorento 2010

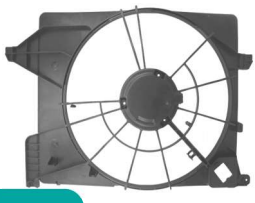

90974 / CRV 07/11
Lado Motorista



90975 / CRV 07/11
Lado Carona

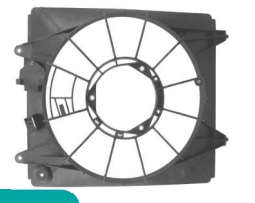

90976 / CRV 00 / 06
Lado Carona



90979 / Captiva 2008 C/ Ar Duplo

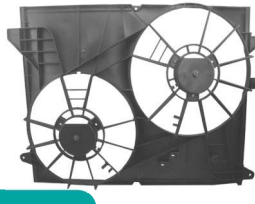

90980 / Tucson 2.0 2005
Suporte Alto

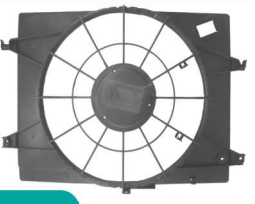

90983 / Tucson 2.7 05 / 11
Suporte Alto C/ Ar

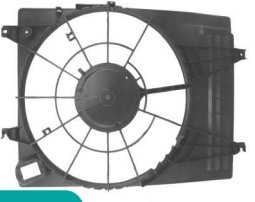

90984 / Focus 04 C/ Ar Duplo



90985 / Focus 1.6 Moderno
10 C/ Ar



90986 / KA Moderno 10
Fiesta Zetec Rocam

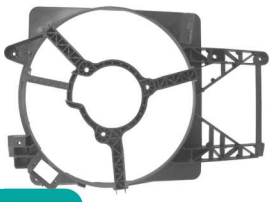

90987 / Golf / Bora / Fox
99 / 09 C/ Ar

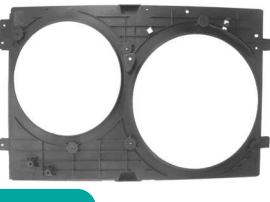

90989 / Duster 2012

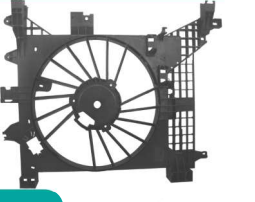

90992 / Tucson 2.7 05>
Suporte Baixo

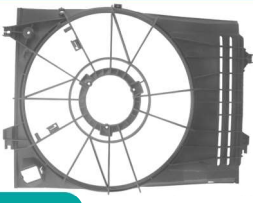

90993 / Ix35 / Tucson 10 C/ Ar



90994 / Corolla C/ Reservatório
Fielder C/ Ar



90995 / Corolla Até 01 C/ Ar



90999 / Civic 1.3 / 1.5 / 1.6
92 / 99



93000 / Frontier C/ Ar 03>



93001 / Argos 17> / Cronos 18>
Pulse 22>



99781 / New Logan / New Sandero
2014 S/ Ar

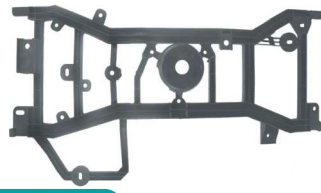

99905 / Uno Vivace / Palio
Siena Similar Valeo S/ Ar



99938 / Agile / Montana 2017 C/ Ar

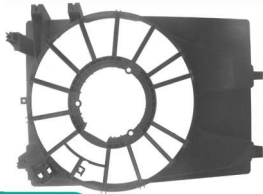

99944 / Kicks 2016>

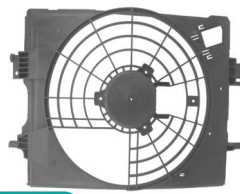

99945 / Civic Aspirado 16>



99946 / Civic Turbo 16>



99947 / Sentra Duplo 2008>



99948 / March/ Versa Até 13

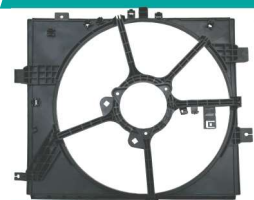

99949 / Sentra 14>

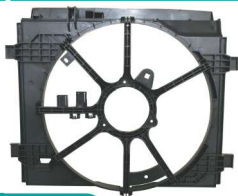

99950 / ASX / Lancer 09>

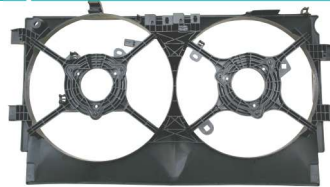

99951 / Outlander 09 / 13

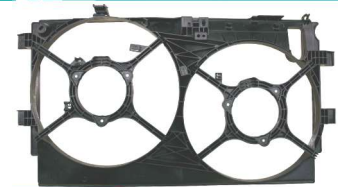

99952 / Outlander 14>



99953 / Airtrek 03 / 08



99954 / PT Cruiser 2006> C/ Ar



99955 / Grand Vitara 10>



99956 / Volvo S60/S80/V60/XC60
XC70 2007> Evoque

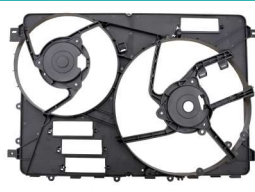

99957 / Fusion 2.5/3.0 10/13



99958 / Fusion 2014> Duplo

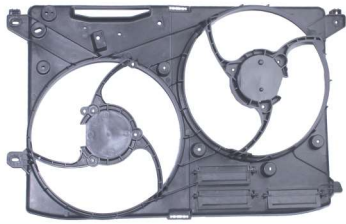

99959 / Ducato/ Jumper/ Boxer 18> Duplo

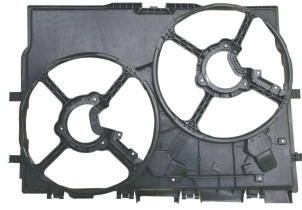

99960 / Scenic Logan AT 1999>

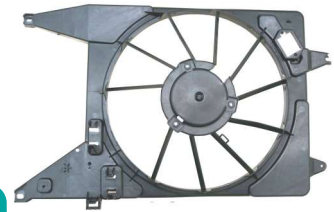

99961 / Ducato/Boxer/Jumper 99



99962 / Civic 12>15

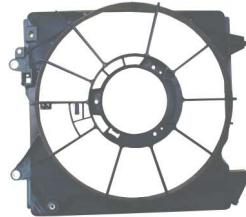

99963 / C3 / Aircross 11>



99965 / Master 14/19 2 Eletros

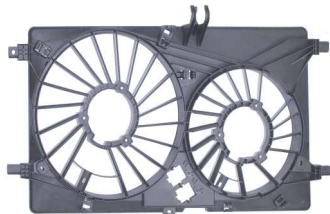

99966 / Accord 2,0 08>



99967 / Accord 2.4 08>

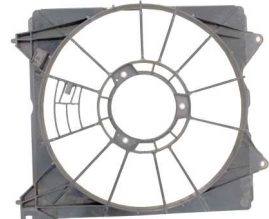

99968 / Audi A4 / Passat Alemão Do Ar



99969 / Focus 1.6 / 2.0 14 / 19



99970 / Creta 2017>



99971 / Grand Vitara 2008> Dupla

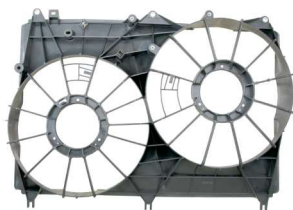

99973 / Jeep Compass 2017>



99976 / Toyota Corolla 2020>



99977 / Air Cross C3 2013 / 2017



99978 / Grade Corsa / Montana 03/09

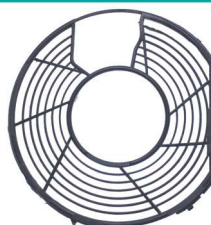

99979 / Yaris 18 / 19

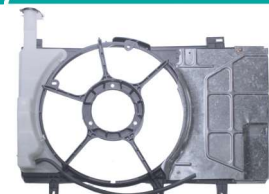

90025 / Gol G2 / Escort

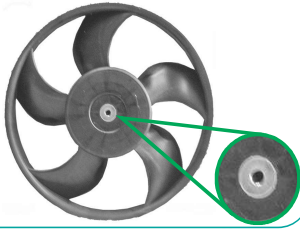

90026 / Palio Fire S/ Ar Similar Behr
Montana 7 Pás P

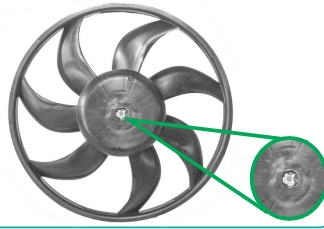

90027 / Gol G3 / G4

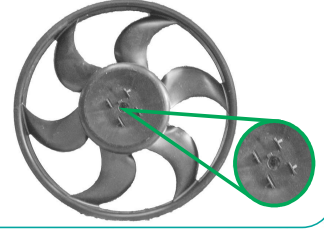

90029 / Fit 03/08 New Fit 09/14
City 11/14

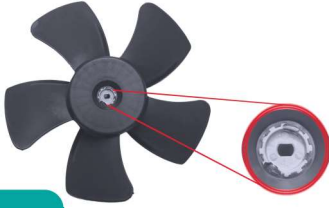

90042 / Gol G5 C/ Ar

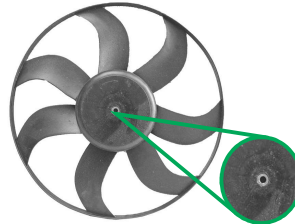

90043 / Palio Fire Similar Valeo
Celta/Prisma/Uno Fire 5 Pás

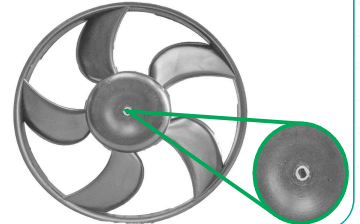

90044 / Palio 1.0 / 1.5 / Uno Antigo

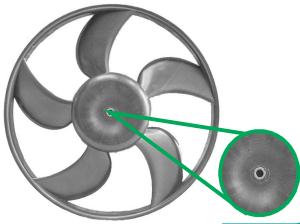

90046 / Palio Fire Similar Behr/ Peugeot 206/207
Montana/Doblò Antiga 03/07 7 Pás C/ Ar G

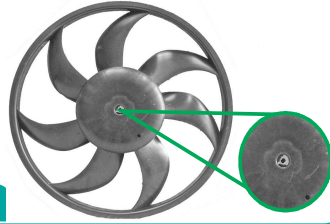

90047 / Condensador
Astra / Vectra P

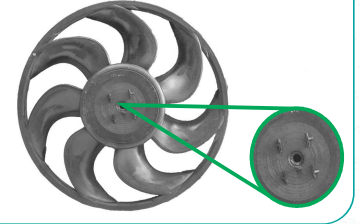

90052 / New March

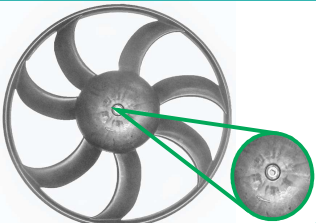

90054 / Astra / Vectra
Zafira / Meriva G

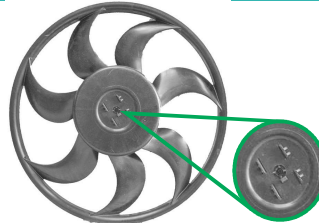

90055 / Celta Flex C/S/Ar 11 Pás

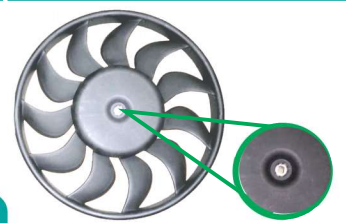

90056 / Celta, Fiesta e Courier
7 Pás

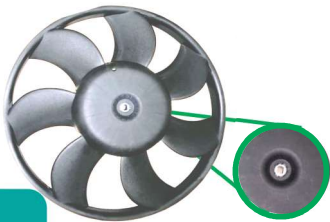

90101 / Civic 01/06 / Corolla 92/01

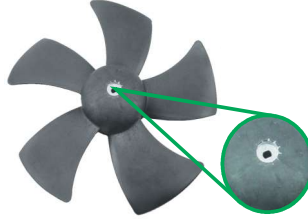

90102 / Gol G5 Inseto Meia Lua

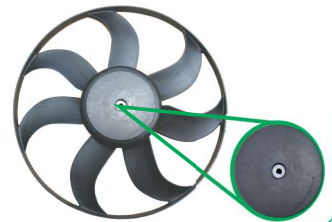

90109 / Gol G5 Inseto Quadrado

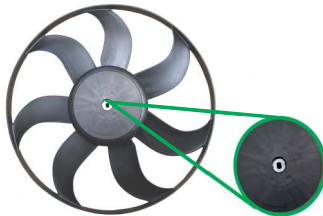

90220 / Gol G5 S/ Ar

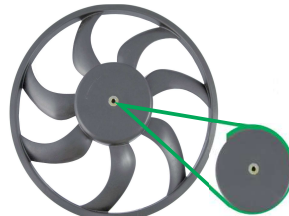

90516 / Uno Novo/Grand Siena
Palio 2010> Mobi Denso

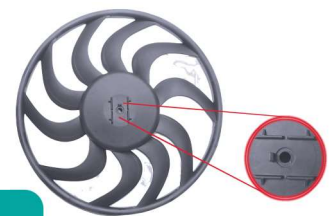

HÉLICES

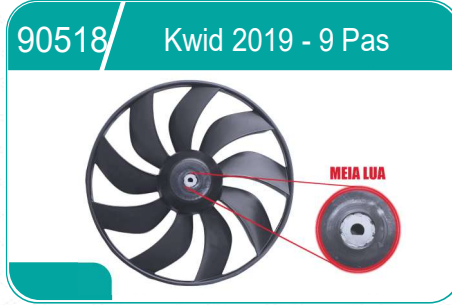

ELETROVENTILADORES

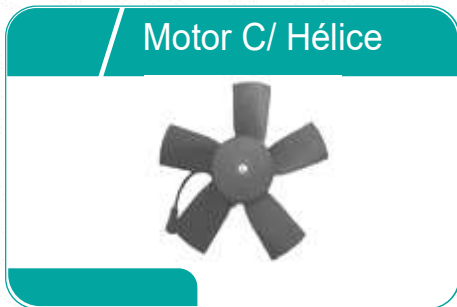

TRIPÉS

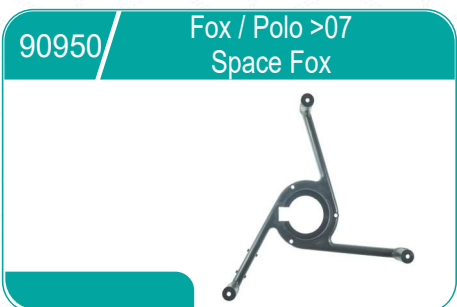
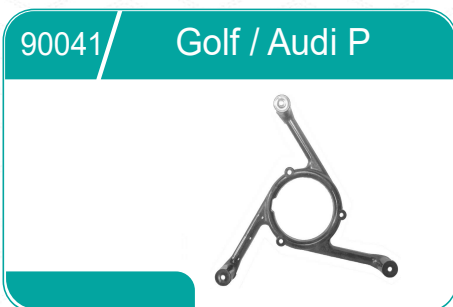
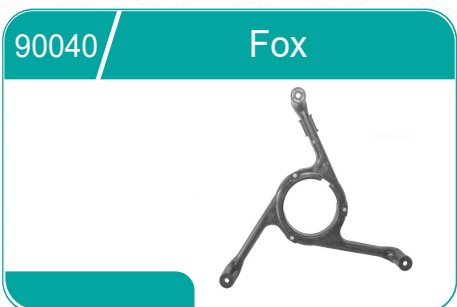

1755/ Tampa P/ Reservatório
Água do Defletor Hb20



1858/ Tampão do Axor



1859/ Kit Tampão Sandero



1861/ Suporte do Radiador
Palio 1.0



1862/ Suporte do Radiador
Palio 1.5



1863/ Suporte do Radiador
Palio Adventure



1864/ Suporte do Radiador
Palio Weekend



1865/ Suporte do Radiador
Palio Fire



1866/ Suporte do Radiador
Fiorino/Spazio/Elba/Uno



1867/ Torneira P/ Sangrador
Doblò / Marea Largo



1868/ Kit Linha Palio: 2 Calços e
3 Arruelas borracha P/ Defletor



1871/ Torneira P/ Sangrador
Palio 1.5



1872/ Torneira P/ Sangrador
Corolla 2009 P



1873/ Torneira P/ Sangrador
Corolla 2009 G



1874/ Suporte Coxim do Gol G5



1875/ Sangrador Iveco Daily



1876/ Suporte do Radiador
Idea Novo



1877/ Suporte Ecosport/Ka
New Fiesta



1878/ Tampão P/ Retorno
do Fiesta

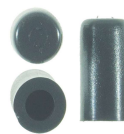

1882/ Torneira P/ Sangrador
Marea



1883/ Torneira P/ Sangrador
Honda



1887/ Retorno d'água Scania



1888/ Torneira P/ Sangrador
Palio Fire Sim. Visconde



1889/ Torneira P/ Sangrador
Gol/Palio Similar Valeo



1894/ Tampão Scania



1895/ Suporte do Radiador
Uno Fire



1908/ Kit Tampão Peugeot
CHT 19



1915/ Tampão DAF



4000 / Suporte do Radiador 01 Similar Behr



4001 / Suporte do Radiador 02 Similar Behr



4002 / Suporte do Radiador 03 Similar Behr



4003 / Suporte do Radiador 04 Similar Behr



4004 / Torneira P/ Sangrador Iveco Eurocargo/Focus



5001 / Retorno Peugeot



5002 / Torneira P/ Sangrador Iveco Strallis



5003 / Torneira P/ Sangrador Mercedes Benz 0500



5004 / Torneira P/ Sangrador Captiva/Cruze P



5005 / Torneira P/ Sangrador Capitiva/Cruze G



5006 / Torneira P/ Sangrador Accelo



5007 / Torneira P/ Sangrador Spin/Cobalt/Onix P



5008 / Torneira P/ Sangrador Spin/Cobalt/Onix G



5009 / Torneira P/ Sangrador Caterpillar/ Case



5012 / Suporte Superior Esq. Montana / Corsa Novo



5013 / Suporte Superior Esq. Corsa Classic 94/17



5014 / Suporte Superior Prisma 06/12 Celta 01/16



5015 / Suporte Superior Dir. Vectra 97/05



5016 / Suporte Superior Dir. Corsa Classic 94/17



5017 / Suporte Superior Esq. Vectra 97/05



5018 / Suporte Inferior Astra 99/11 Zafira 01/12



5019 / Suporte Superior Dir. Corsa Classic 94/17 S/Ar



5020 / Kit Torneirinha BMW X1 116I/118I/120I/130I/316I>04



5021 / Suporte Superior Dir. Montana/Corsa/Meriva



5022 / Suporte Superior Esq. Montana/Corsa/Meriva



5023 / Suporte Superior Montana 11/21 Agile 10/14



5024 / Coxim Superior Suporte Montana/Meriva/Corsa



RESERVATÓRIO DE EXPANSÃO - FLÓRIO

TRABALHAMOS COM RESERVATÓRIOS DE EXPANSÃO DE DIVERSOS OS MODELOS



CONSULTE-NOS

TAMPAS DE RADIADORES E RESERVATÓRIO DE EXPANSÃO



TRABALHAMOS COM TAMPAS DE RADIADORES E RESERVATÓRIOS DE EXPANSÃO DIVERSOS MODELOS

CONSULTE-NOS

ACESSÓRIOS

Porca



Trava hélice



Kit punção



CORDÕES DE VEDAÇÃO

- 1499 Esponjoso redondo 4mm
- 1500 Esponjoso redondo 5mm
- 1510 Esponjoso redondo 6mm
- 1520 Esponjoso redondo 8mm
- 1525 Rígido redondo 5mm
- 1529 Rígido 3 x 5mm
- 1530 Rígido 4 x 5mm
- 1531 Esposjoso 6 x 4mm
- 1532 Esponjoso 3mm
- 1550 Rígido 6 x 3mm

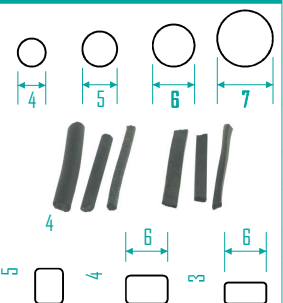

ABRAÇADEIRAS SUPRENS

- 2429 PAB 22 x 32 - fita 9mm - pct. c/ 10
- 2430 PAB 25 x 38 - fita 9mm - pct. c/ 10
- 2431 PAB 89 x 108 - fita 9mm - pct. c/ 10
- 2432 PAB 32 x 44 - fita 9mm - pct. c/ 10
- 2433 PAB 32 x 44 - fita 14mm - pct. c/ 10
- 2434 PAB 38 x 51 - fita 9mm - pct. c/ 10
- 2436 PAB 44 x 57 - fita 9mm - pct. c/ 10
- 2438 PAB 51 x 64 - fita 9mm - pct. c/ 10
- 2440 PAB 57 x 76 - fita 9mm - pct. c/ 10
- 2442 FAB 13 x 19 - fita 14mm - pct. c/ 10
- 2443 FAB 19 x 27 - fita 14mm - pct. c/ 10
- 2444 FAB 25 x 38 - fita 14mm - pct. c/ 10
- 2446 FAB 38 x 51 - fita 14mm - pct. c/ 10
- 2448 FAB 44 x 57 - fita 14mm - pct. c/ 10
- 2450 FAB 57 x 76 - fita 14mm - pct. c/ 10
- 2451 FAB 51 x 64 - fita 14mm - pct. c/ 10
- 2452 FAB 70 x 89 - fita 14mm - pct. c/ 10
- 2454 FAB 102 x 121 - fita 14mm - pct. c/ 10
- 2456 FAB 114 x 133 - fita 14mm - pct. c/ 10
- 2458 MAB 9 x 13 - micro - pct. c/ 10
- 2459 MAB 19 x 27 - micro - pct. c/ 10
- 2460 MAB 12 x 16 - micro - pct. c/ 10
- 2461 MAB 22 x 32 - micro - pct. c/ 10
- 2462 MAB 13 x 19 - micro - pct. c/ 10
- 2463 MAB 14 x 22 - micro - pct. c/ 10
- 2464 FIF 70 x 89 - inox 14mm - pct. c/ 5
- 2466 FIF 83 x 102 - inox 14mm - pct. c/ 5
- 2468 FIF 114 x 133 - inox 14mm - pct. c/ 5
- 2469 Abraçadeira de Nylon 4,8x300mm pct c/100
- 2470 TUCHO 57 x 65 - inox - pct. c/ 2
- 2472 TUCHO 68 x 77 - inox - pct. c/ 2
- 2473 TUCHO 74 x 83 - inox - pct. c/ 2
- 2474 TUCHO 80 x 89 - inox - pct. c/ 2



BORRACHAS DE VEDAÇÃO

- 1200 Apollo e Verona
- 1210 Corcel e Escort
- 1220 Corsa
- 1230 Fiat 147
- 1240 Gol e Passat
- 1241 Gol e Passat p/ radiador visconde
- 1250 Gol bola
- 1260 Intercooler
- 1270 Kadett
- 1280 Monza
- 1290 Opala e Chevette
- 1300 Palio 1.0
- 1310 Palio 1.5
- 1320 Palio Fire / Peugeot e Renault
- 1330 S10
- 1340 Santana
- 1345 Prisma / Ecosport
- 1350 Uno
- 1355 Celta Prisma
- 1371 Corsa Montana
- 1372 Gol G5



2258-FIXADOR DE TANQUE DO RADIADOR (SARGENTO)



2701 - KIT ALICATE AB/FEC



ACESSE NOSSO SITE

ANEL DE VEDAÇÃO

- 1360 Astra e Zafira - 38mm x 380mm
- 1361 Zafira e Vectra novo - 54mm x 370mm
- 1362 Astra 2010 Fino - 30mm x 385mm
- 1363 Anel de vedação - Valtra
- 1364 Anel de vedação Ford Cargo Curto
- 1365 Scania Série 6 P
- 1366 HR
- 1367 Vectra/Zafira/Astra C/ Orelha
- 1368 Astra/Zafira 26 - C/ Orelha
- 1369 Valtra 530x124 - C/ Orelha
- 1370 Corsa - 45mm x 275mm
- 1373 Valtra 640x120 C/ Orelha
- 1374 Actros
- 1376 Scania Serie 6 M
- 1377 Scania Serie 6 G
- 1379 Ategão
- 1380 Fiat e LX - Argentino - 45mm x 320mm
- 1381 FH Nova
- 1382 Man TGX
- 1383 Acello
- 1390 Fiesta, Ka e Ecosport - 50mm x 378mm
- 1400 Ford Corcel / Escort - 48mm x 313mm
- 1410 Ka / Focus - Brazado - 45mm x 365mm
- 1420 Gol bola c/ ar - 58mm x 325mm
- 1421 Gol bola canelado c/ ar - 50mm x 330mm
- 1422 Palio Fire Similar RV
- 1424 MB O-500 - 90mm x 655mm
- 1425 Ford Cargo Grande
- 1426 Corolla fino
- 1427 Volvo VM
- 1428 Scania 124 Série 5 G
- 1429 Honda Civic
- 1430 Volvo FMX
- 1435 Volvo FH 12 - 77mm x 900mm
- 1436 MB Axor - 77mm x 694mm
- 1438 VW Constellation - 77mm x 670mm
- 1445 MB - 1721 / 1620 - 73mm x 636mm
- 1446 MB O-400 - 68mm x 720mm
- 1447 Scania 124 série 4 - 77mm x 910mm
- 1448 Scania P 94 - 55mm x 700mm
- 1450 Monza e Kadett - Brazado - 44mm x 420mm
- 1451 Peugeot 206 - 42mm x 555mm
- 1452 Scania 124 série 5 P - 56mm x 704mm
- 1453 Scania 124 série 5 M - 56mm x 940mm
- 1460 MB Sprinter - 56mm x 424mm
- 1470 Tempra - 47mm x 355mm
- 1480 Tipo - 47mm x 380mm
- 1490 Vectra / Meriva - 53mm x 372mm
- 1491 MB 709 / 912 - 60mm x 433mm
- 1492 MB 1418 / O-366 - 73mm x 632mm
- 1497 Volvo FM - 73mm x 737mm
- 1498 Iveco Stralis - 68mm x 766mm
- 1501 Mercedes
- 1502 Renault Kwid
- 1503 Caterpillar
- 1504 John Deere
- 1505 Iveco Eurocargo Tector
- 1506 New Civic / Marea
- 1507 Citroen C3 / Onix Novo
- 1508 DAF

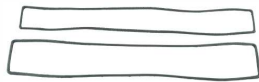

ANEL DE VEDAÇÃO

- 1509 O500
- 1511 Iveco Daily 2013
- 1512 Scania Serie 7 C/ Bico
- 1513 Massey Ferguson
- 1514 Corolla
- 1515 John Deere 6000
- 1516 Case MX 180 C/ Tampa
- 1517 Iveco Eurocargo Tector
- 1518 Atego
- 1519 Mercedes 1634
- 1521 Onix

CONEXÕES E ADAPTADORES

- 2233 Conexão de para Rad c/7pçs
- 2234 Conexão para Radiadores Nº1
- 2235 Conexão para Radiadores Nº2
- 2236 Conexão para Radiadores Nº3
- 2237 Conexão para Radiadores Nº4
- 2238 Conexão para Radiadores Nº5
- 2239 Conexão para Radiadores Nº6
- 2241 Conexão para Radiadores Nº7
- 2242 Engate Rápido do Uno Vivace
- 2243 Conexão Fluxo Água > Audi A3 Turbo 1.8 03
Audi A4 Turbo 1.8 03/ Golf Bola Turbo 1.8 04 /
New Beetle Turbo 1.8 03
- 2244 Plug Tampão do Reservatório do Radiador
- 2245 Adaptador 90º bico Longo C/ Anel de Viton
- 2246 Adaptador T - C/ Anel Viton
- 2247 Adaptador Y - 6mm S/ Anel
- 2248 Adaptador Reto Bico Longo C/ Anel Viton
- 2249 Conexão Água Ar Quente - Audi A3 98/06
- 2251 Conexão Água Ar Quente - Audi A3 00/06
- 2252 Flange Válvula Termostática - Passat / Gol
- 2253 Cotovelo de Saída de Água Fox / Polo
- 2254 Conexão Y P/ Mangueira - Golf / A4 1.6
- 2255 Conexão Fluxo Água - Golf / Audi / A4
- 2256 Conexão Fluxo Água > polo sedan, Cordoba
- 2259 Conector de Fluxo de Água
- 2261 Flange C/ Anel Vedação
- 2262 (01.06.030) Flange Fluxo Água
- 2263 (01.06.033) Flange Fluxo Água
- 2223 Conexão Rápida Superior Radiador Fox 1.0-1.6
03/04 / Spacefox 1.6 8v Gas. Flex 06 / Polo Hatch /
Polo 1.4 / 1.6 02 / Polo Sedan 02 / Jetta 2.5 Tiptronic 06
Jetta Variant My 06 / 08
- 2224 Conexão Rápida Radiador Golf A4 98 / Fox / Bora
00/04 / Bora my 07 / 08 hatch / sedan 02 / GTI 06 /
Golf My 07 08
- 2277 Conexão iveco Daily Euro 3.0



TAMPÃO DE TESTES

- 2008 Nº 5 fechado / 2019 aberto
- 2009 Nº 6 fechado / 2021 aberto
- 2011 Nº 7 fechado / 2022 aberto
- 2100 Nº 8 fechado - Passat, Santana, Escort... / 2023 aberto
- 2110 Nº 9 fechado - Corcel II, Fiat 147... / 2024 aberto
- 2120 Nº 10 fechado - Mangueira Opala sup., metal sup., Chevette metal inf. / 2025 aberto
- 2130 Nº 11 fechado - Superior e inferior Mercedes Benz 1113 e afins inf., Chevette metal / 2026 aberto
- 2140 Nº 12 fechado - Mercedes Benz 1519 e Ônibus / 2027 aberto
- 2150 Nº 13 fechado - Opala metal inf. e sup., inf. caminhão, Chevette, Scania 111, 366 Volvo Ônibus / 2028 aberto
- 2160 Nº 14 fechado - Mangueira inf. caminhão e caminhonete Ford / 2029 aberto
- 2170 Nº 15 fechado - Scania 112 e 366 / 2036 aberto
- 2180 Nº 16 fechado - Colheitadeira e Tratores pesados / 2031 aberto
- 2190 Nº 18 fechado - Intercooler NL 10/12 / 2033 aberto
- 2200 Nº 19 fechado - Intercooler AR - 1620, 1721, 914 / 2034 aberto
- 2210 Nº 20 fechado - Intercooler Scania, Volvo, 0370, 0371, 0400, 1933 e Ônibus / 2035 aberto
- 2220 Nº 21 fechado Intercooler Mercedão 1935, 1941 / 2037 aberto



COXIM DO RADIADOR

- 1820 Coxim do Radiador: 1111, 1113, 1313, 2013, 2213, 2215, 2513 | Pct. c/ 2 Pçs.
- 1823 Coxim G5 / Fox / Voyage - Pct C/ 4 Pçs.
- 1824 Coxim Uno Inferior - Pct C/ 4 Pçs.
- 1830 Coxim Superior do Radiador: 608-D | Pct. c/ 10 Pçs.
- 1832 Coxim Maior / Menor G5 / Fox / Voyage - (Par)
- 1835 Coxim do Radiador Pequeno: Passat
- 1840 Coxim Inferior do Radiador: 608-D | Pct. c/ 10 Pçs.
- 1841 Coxim Inferior do Radiador: Chevette 73/93, Chevy 84/95, Marajó 81/89
- 1842 Coxim Inferior do Radiador: Caravan 74/92, Chevette 73/93, Chevy 84/95, Marajó 81/89, Opala 62/92
Pct. c/ 10 Pçs.
- 1843 Coxim inferior do Radiador: A-C-D-10 67 / 84 , A-C-14 85/89 Pct. C/10 Pçs
- 1844 Coxim Palio Inferior Pct. c/ 4 Pçs.
- 1845 Borracha Lateral do Radiador: Chevette 73/93, Chevy 84/95, Marajó 81/98 | Pct. C/ 10 Pçs.
- 1850 Coxim do Radiador Pequeno: Passat / Royale / Versailles 91
- 1860 Coxim do Radiador Grande: Passat / Royale / Versailles 91



BOCAIS

- 1869 Boquilha de Latão - Mercedes
- 1870 Boquilha de Latão - P/ Importados
- 1880 Boquilha de latão - Universal
- 1885 Boquilha de Alumínio - P/ Importados
- 1886 Boquilha de Alumínio - Universal
- 1891 Mangueira Metal Superior 1113
- 1892 Mangueira Metal Inferior 1113
- 1893 Tubo do Bocal Metal 1113



ESCOVAS

- 1910 Escova C/ Cabo de Madeira, 3 Fileiras
- 1911 Escova C/ Cabo de Madeira, 4 Fileiras
- 1920 Escova de Aço S/ Cabo
- 1921 Escova de Aço C/ Cabo Plástico

Caixa Com 12 Unidades



GRAMPOS E TAMPÕES

- 1884 Anel do Tampão de Cebolão - Pct. C/10 (Papelão)
- 1899 Anel do Tampão de Cebolão - Pct. C/10 (Borracha)
- 1930 Grampo - Pct. C/10
- 1940 Tampão Cebolão - Pct. C/10



SOLDAS DE ESTANHOS

- 2010 Solda 30 x 70
- 2020 Solda 40 x 60
- 2030 Solda 50 x 50
- 2040 Estanho Virgem
- 2050 Lingote de Chumbo



FLUXOS

- 2060 Cloreto de Zinco Bomba Com 7,5 Kg
- 2063 Gel Para Hélice Viscosa 5 Litros
- 2065 Cloreto de Zinco Bomba de 60 Litros
- 2097 Limpa Baú BB 20 Litros
- 2098 Limpa Baú 5 Litros
- 2106 Gel Para Hélice Viscosa 1 Litro



ADITIVOS SS

- 2090 Aditivo SSfluid Concentrado Verde
- 2091 Aditivo SSFluid Concentrado Rosa
- 2096 Aditivo SSRad Rosa
- 2101 Aditivo SSRad Verde
- 2102 Aditivo SSRad Azul
- 2103 Aditivo SSRad Amarelo
- 2105 Água Desmineralizada SS
- 2108 Aditivo SSFluid Concentrado Azul
- 2111 Aditivo SSRad Rosa galão 5L
- 2112 Aditivo SSRad Verde galão 5L
- 2113 Aditivo SSRad Azul galão 5L
- 2115 Aditivo SSRad Amarelo galão 5L
- 2116 Água BI-Desmineralizada SS galão 5L



MAÇARICO E ACESSÓRIOS

- 3000 Maçarico - Iron
- 3020 Bico Nº1 - Iron
- 3030 Bico Nº2 - Iron
- 3040 Bico Nº3 - Iron
- 3050 Ponteira de Cobre - Iron



TINTAS

- 1890 Lata Com 3,6 Litros - Cor Preta
- 1900 Lata Com 18 Litros - Cor Preta
- 1901 Lata Com 3,6 Litros Caterpillar - Cor Amarelo Peq.
- 1902 Lata Com 18 Litros Caterpillar - Cor Amarelo Grd.
- 1903 Lata Com 3,6 Caterpillar - Cor Alumínio
- 1904 Lata Com 18 Litros - Cor Alumínio



ADITIVOS SS / DIVERSOS



1 LITRO



RADNAQ



SS



5 LITROS

KIT PARA TESTE INTERCOOLER/RADIADOR



COD:2221



COD:2222



COD:2226



COD:2265

SOLDAS ESPECIAIS

- 1950 Aluminex pó - 200g
- 1951 Aluminex SS pó - 200g
- 1952 Fluxo de prata - 250g
- 1953 Trincal Fluxo Oxi-Acetileno - 250g
- 1960 Aluminex Past - 200g
- 1961 Poly Plus (Pó) - 935g
- 1962 Poly Plus (Resina) - 1030g
- 1964 Vareta Foscofer S/ Prata (Uniweld) (Kg)
- 1965 Vareta Latão P/ Solda Amarelo (Uniweld) (Kg)
- 1966 Fluxo P/ Vareta de Latão (Uniweld) - 100g
- 1967 Aluminex Fluxo P/ Vareta (Uniweld) - 200g
- 1968 Solda Cobix Pasta - 110g
- 1970 Poly Plus Kit - 1.965g
- 1973 Poly Plus Kit - 195g
- 1974 ADS-20 Araldite Industrial 24h - Conj - 900g
- 1975 ADS-20 Araldite Industrial 24h - Conj - 400g
- 1976 ADS-22 Araldite Rápido 10m - Conj - 500g
- 1980 Tubolit Cola 301 - 1000g
- 1981 Poly Plus (Resina) - 90g
- 1996 Tinex Fluxo Para Solda - 300g
- 1998 Vareta Izi Migrare 1 (Unidade)
- 1999 Vareta Silício 40/47 12% Ox 12 1/8 (Grossa) (Kg)
- 2000 Vareta Silício 40/47 12% Ox 12 3/32 (Fina) (Kg)
- 2001 Trincalox - 250g
- 2002 Foscofer Com Prata (Kg)
- 2003 Vareta Silício - 40/43 2,4 (Kg)
- 2007 Aron para Solda Foscofer Latão - 200g
- 2012 Vareta SS100 - P/ Evaporadores + Rad. de Alum. (Kg)
- 2013 Vareta SS500 - P/ Soldar Alumínio, Latão e Cobre (Kg)
- 2014 Fluxo Essen AG Flux - 100g
- 2015 Solda Alumax-C - 71g
- 2018 Vareta Izi Migrare 7 (Unidade)



RADIADORES E COLMEIAS

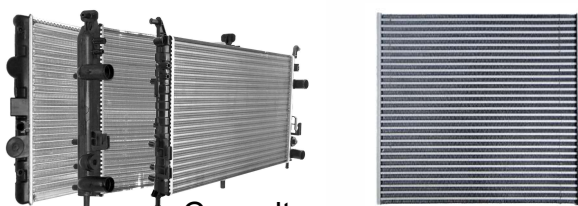

Consulte

RADIADORES DE ÓLEO



80197 HR

INTERCOOLER

40026 /

Kia Bongo



80189 /

HR



CAIXAS DE LATÃO, KITS E LATERAIS



4101- MB14171



4031- MB30255

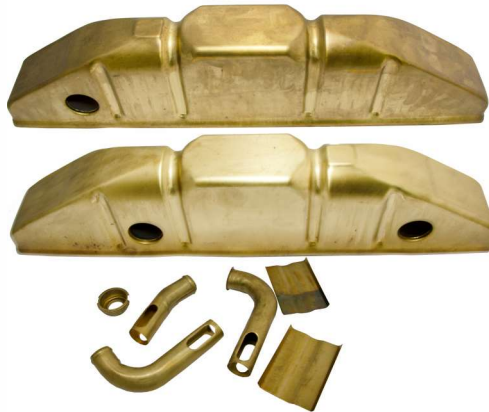

4021- MB300114

CAIXAS DE INTERCOOLER



9209 MBB Atego superior - 3407



9233 MBB Axor superior Behr - 3804



9234 MBB Axor inferior Behr - 3805

9210 MBB Atego inferior - 3731



9237 MBB Axor superior Valeo - 3808



9236 Iveco Tractor / Eurocargo (LD) - 3803



9238 MBB Axor inferior Valeo - 3807



9235 Iveco Tractor / Eurocargo (LE) - 3802



9208 MBB Sprinter - 3444